



# 24th World Mining Congress

MINING IN A WORLD OF INNOVATION

October 18-21, 2016 • Rio de Janeiro /RJ • Brazil



## 24<sup>th</sup> World Mining Congress **PROCEEDINGS**



## AUTOMATION AND ROBOTICS

Promotion:



**IBRAM**

INSTITUTO BRASILEIRO DE MINERAÇÃO  
Brazilian Mining Association  
Câmara Mineira de Brasil

Diamond Sponsorship:



Gold Sponsorship:



Bronze Sponsorship:



Special Sponsorship:



Special Support:



Communication Agency:



Operations Management:



Executive Producer and Marketing:



Commercial Partner – India:



Commercial Partner – Canada/USA:



Promotion:



**IBRAM**  
INSTITUTO BRASILEIRO DE MINERAÇÃO  
Brazilian Mining Association  
Câmara Mineira de Brasil

# 24<sup>th</sup> World Mining Congress **PROCEEDINGS**

## AUTOMATION AND ROBOTICS

October 18-21, 2016  
Rio de Janeiro /RJ • Brazil



**IBRAM**  
INSTITUTO BRASILEIRO DE MINERAÇÃO  
Brazilian Mining Association  
Câmara Mineira de Brasil

#### **IBRAM sede**

SHIS QL 12, Conjunto 0 (zero), Casa 04,  
Lago Sul – Brasília/DF – CEP: 71.630-205  
Phone: +55 (61) 3364-7272 / (61) 3364-7200  
[ibram@ibram.org.br](mailto:ibram@ibram.org.br)

#### **IBRAM Minas Gerais**

Rua Alagoas, 1270, 10º andar  
Funcionários – Belo Horizonte/MG  
CEP: 30130-168  
Phone: +55 (31) 3223-6751  
[ibram-mg@ibram.org.br](mailto:ibram-mg@ibram.org.br)

#### **IBRAM Amazônia**

Travessa Rui Barbosa, 1536 – B. Nazaré  
Belém/PA – CEP: 66035-220  
Phone: +55 (91) 3230-4066  
[ibramamazonia@ibram.org.br](mailto:ibramamazonia@ibram.org.br)



[www.ibram.org.br](http://www.ibram.org.br)



[https://www.facebook.com/  
InstitutoBrasileirodeMineracao/](https://www.facebook.com/InstitutoBrasileirodeMineracao/)

## **IBRAM GOVERNANCE**

### **Executive Directors**

*José Fernando Coura* | CEO  
*Marcelo Ribeiro Tunes* | Director of Mining Affairs  
*Rinaldo César Mancin* | Director of Environmental Affairs  
*Walter B. Alvarenga* | Director of Institutional Relations  
*Ary Pedreira* | Chief Financial Officer

### **Board of Directors**

CHAIRMAN | Vale S.A. | Clovis Torres Junior – Member  
VICE CHAIRMAN | Embú S.A. Engenharia e Comércio | Luiz Eulálio Moraes Terra – Member

### **Conselours**

**Anglo American Brasil** | *Ruben Fernandes* – Member | *Arthur Liacre* – Alternate | **Anglogold Ashanti Ltda.** | *Hélcio Roberto Martins Guerra* – Member | *José Margalith* – Alternate | **Companhia Siderúrgica Nacional – CSN** | *Benjamin Steinbruch* – Member | *Luiz Paulo Teles Barreto* – Alternate | **Copelmi Mineração Ltda.** | *Cesar Weinschenck de Faria* – Member | *Carlos Weinschenck de Faria* – Alternate | **Embú S.A. Engenharia e Comércio** | *Daniel Debiazzi Neto* – Alternate | **Gerdau Açominas Brasil S.A.** | *Aloysio Antonio Peixoto de Carvalho* – Member | *Francisco de Assis Lafeté Couto* – Alternate | **Kinross Brasil Mineração S.A.** | *Antonio Carlos Saldanha Marinho* – Member | *Ricardo Rodrigues dos Santos* – Alternate | **Mineração Paragominas S.A (Hydro Brasil)** | *Alberto Fabrini* – Member | *Anderson de Moraes Baranov* – Alternate | **Mineração Rio do Norte S.A. – MRN** | *Silvano de Souza Andrade* – Member | *Luiz Henrique Diniz Costa* – Alternate | **Minerações Brasileiras Reunidas S.A. – MBR** | *Edmundo Paes de Barros Mercer* – Member | *Solange Maria Santos Costa* – Alternate | **Samarco Mineração S.A.** | *Roberto Lúcio Nunes de Carvalho* – Member | *Fernando Schneider Künsch* – Alternate | **Vale S.A.** | *Salma Torres Ferrari* – Member | *José Ribamar Brasil Chehebe* – Alternate | *Marconi Tarbes Vianna* – Member | *Silmar Magalhães Silva* – Alternate | *Lúcio Flavo Gallon Cavalli* – Alternate | **Votorantim Metais Zinco S.A.** | *Jones Belther* – Member | *Guilherme Simões Ferreira* – Alternate

### **Technical Staff**

*Cinthia Rodrigues* | *Cláudia Salles* | *Edileine Araújo* | *Edmilson Costa* | *Osny Vasconcellos*

### **Communication Agency**



Profissionais  
**do Texto**

COMUNICAÇÃO CORPORATIVA

## **Catalog Card**

24<sup>th</sup> World Mining Congress (24: 2016: Rio de Janeiro, RJ)

24<sup>th</sup> World Mining Congress PROCEEDINGS – AUTOMATION AND ROBOTICS /  
Brazilian Mining Association/Instituto Brasileiro de Mineração (Org). 1ed. - Rio de  
Janeiro: IBRAM, 2016. e-book

Event held between 18<sup>th</sup> to 21<sup>st</sup> October 2016.

Available at: [www.wmc2016.org.br](http://www.wmc2016.org.br) and [www.ibram.org.br](http://www.ibram.org.br)

126 p.

ISBN: 978-85-61993-11-5 e-book

1- Mining. 2- Innovation. 3- Automation and Robotics. I- Title. II- 24<sup>th</sup> World  
Mining Congress. III- Instituto Brasileiro de Mineração.

CDU: 622/5: 502/504

At Vale we bring  
together the best  
technologies and  
the best researchers.

Photos by © Giorgio Venturieri



VALE INSTITUTE OF TECHNOLOGY



Access [www.itv.org](http://www.itv.org) and be part of our team of researchers,  
academics, masters' degree and post-graduation students.

# Vale Institute of Technology

Created in 2009 with the purpose of stimulating innovation, competitiveness and sustainability in Vale's operations, Vale Institute of Technology (ITV) is a non-profit organization that develops research activities, with emphasis on H2 and H3 horizons as well as training of resources human at post-graduate level. ITV has two locations: one in Belém in the State of Pará, focused on matters related to Sustainable Development, and the other in Ouro Preto, MG, dedicated to Mining and Mineral processing topics.

At the ITV unit in Belém, Vale has been offering a *Master's Degree Program in the Sustainable Use of Natural Resources in Tropical Regions* since 2012. This is a unprecedented initiative in Brazil as it is the first course offered in conjunction with a company from the mineral sector to obtain certification from the Coordination for the Improvement of Higher Education Personnel (Coordenação de Aperfeiçoamento de Pessoal de Nível Superior - Capes), of the Ministry of Education.

In Minas Gerais, ITV launched a pioneering partnership with Universidade Federal de Ouro Preto (UFOP) to structure the *Master's Degree Course in Instrumentation, Control and Mining Process Systems, and Master's Degree Course in Mineral Engineering*. This course has been approved by Capes in 2015 and classes began in 2016. Another innovative partnership that has been being developed is with the ISPT-Instituto Superior Profissional de Tete, Mozambique, consisting in the offer of courses for the Master's Degree Program in Mining at ISPT. These courses are supported financially and operationally by Vale and Capes.

ITV also provides Specialization courses in Mining for Vale's employees and other courses for professional qualification, as well as research activities comprising levels from scientific research to post-doctoral degree.

Luiz Mello



In partnership with Capes, Vale offers academic postdoctoral scholarships for Brazilians and foreigners to researchers who are selected to work at Vale Institute of Technology units, further bringing together the academic community and Vale, expanding the potential generation of innovation and wealth for Vale and Brazil.

## Performance Segments

ITV activities are focused across three key segments: Research, Education and Entrepreneurship, following the cycle through which scientific production evolves, creating practical application and generation of concrete benefits for the company. For further information visit: [www.itv.org](http://www.itv.org) or send an e-mail: [info.itv@itv.org](mailto:info.itv@itv.org).

It is a pleasure for us to participate in the 24th edition of the World Mining Congress - WMC 2016, being held for the first time in Brazil, and we can introduce you to some of the technological, research and innovation solutions in the Mining Sector. It is our commitment to share knowledge, innovation and technology towards the sustainable development of the operations and processes in global mining.

I hope that everyone enjoys the most of the World Mining Congress!

## **Luiz Mello**

*CEO of Vale Institute of Technology*

*Technology and Innovation Executive Manager of Vale*



## José Fernando Coura

On behalf of the Brazilian Mining Association - IBRAM and its associates, I would like to offer a warm welcome to all the participants of the 24th edition of the World Mining Congress - WMC 2016. This is the first time that the WMC, recognized as one of the most important world mining events, is being held in Brazil. The central theme of this congress is "Mining in a World of Innovation", one of the most current and important issues in the management of mining-sector businesses.

The 24th WMC began to take shape in 2012 when representatives from businesses and entities of the mining sector, as well as the Brazilian government, joined forces to support the country's bid, before the International Organizing Committee, to host the congress (IOC). This was well-deserved, given Brazil is one of the international exponents of mining.

The presentation of the Brazilian bid was made by IBRAM's presidency in conjunction with our Director of Mineral Issues, Marcelo Ribeiro Tunes. It fell to him to deliver the speech underlining the qualities that make IBRAM suitable to organize such an event, of the city of Rio de Janeiro (RJ) to attract and host event participants, and the Brazilian mining industry; factors which proved decisive in convincing the IOC members to choose Brazil as the host of the event in 2016.

With this significant vote of confidence, we are certain that the 2016 WMC will be the stage of an intense diffusion of knowledge, of discussions on the best way forward, and deep analyses of the current and future landscape of the mining industry. Without a doubt, it will also serve as a way to strengthen relationships and enable dialogue between the most diverse actors of the sector's extensive production chain on an international level.

We know that the last few years have been challenging for the mining industry and "innovation" is the key word for new business and the future of the sector itself. The economic environment has altered the rhythm of supply and demand, impacting ore prices and making it more difficult for mining companies to outline their next steps both locally and globally. Nevertheless, this moment offers an opportunity for mining to lay the way for a return to greater productivity in the future.

This is the proposal of the 24th edition of the WMC, amongst others. We also intend to technically and scientifically promote and support cooperation to develop more stages in the sustainable development of operations and processes in the mining sector.

With an optimistic vision of the prospects of the mineral sector, I hope that IBRAM, via this grand event, can awaken the public interest to debate the future of mining and identify innovative actions to further strengthen the mining industry around the world.

We wish everybody an excellent World Mining Congress!

**José Fernando Coura**  
CEO of the Brazilian Mining Institute



## Murilo Ferreira

**B**razil has a historic vocation for mineral extraction activities, and since the mid-18th century they have practically dominated the dynamics of its economy. Rich in world-class minerals, the country has emerged as one of the leading global players in the mining industry, and it is now the second largest iron ore producer and one of the most significant agents in international trading and exports of this commodity.

The mining industry has become one of the most important pillars of Brazil's development. Despite the decline in iron ore prices and demand in the international markets, especially due to the slowdown in Chinese consumption, and despite the end of the super-cycle, the mining sector has continued to play a key role in maintaining Brazil's balance of trade surplus.

In addition to its positive impacts in the macroeconomic sphere in Brazil, mining has also become a driver of social development, particularly as it has a multiplier effect on other economic activities, contributing to the expansion of various production chains and consequently to the generation of jobs and income. It is noteworthy that in the municipalities where mining companies operate, Human Development Index ratings have been higher than the average figures for their respective states, and much higher than in non-mining municipalities.

In a country like Brazil, whose economic growth, as already mentioned, is strongly dependent upon the expansion of mining activities, the creation of the Brazilian Mining Association, which will turn 40 in December, was essential and absolutely necessary. This is a date to be celebrated, above all because IBRAM has played its role to support and strengthen mining activities with dynamism, efficiency and innovative practices. The sector's companies and organizations can count on a body that assertively and competently represents, coordinates and integrates them, defending their interests and generating conditions conducive to the sustainable development and competitiveness of their businesses.

The holding in Brazil of the 24th edition of the World Mining Congress, organized by an entity of IBRAM's quality, is a milestone and an excellent opportunity for the sector to share ideas, discuss, reflect and find stimuli and feasible ways forward at a time when we need to face the end of the mining super-cycle. The theme of the Congress could not be more appropriate, and I am sure that by its end, promising directions will have been mapped to strengthen the mining industry across the world.

**Murilo Ferreira**

Chief Executive Officer, Vale S.A.



## Professor Jair Carlos Koppe



**M**ining has been extremely important to the World's economic growth and prosperity for centuries. The mining industry is currently facing an economic and social crises that can impact strongly the mineral production and productivity. In this scenario several challenges must be addressed, among them complex mineral deposits of low grades, water, social and environmental issues as well as declining commodity prices. Considering that the world is changing dramatically in all aspects this is the moment for innovation in mining. The WMC 2016 is under the umbrella of Mining in a World of Innovation in the proper moment. This is a nice opportunity to change our ways in mining technology considering the new evolving technologies such as automation, sensors, cloud computing, data analytics that can increase the mining production and efficiency in the entire value chain. Let's take this moment to spread our experience among academy, industries, practitioners and professionals of the mining sector focusing in the future of a world in constantly innovation.

We would like to thanks all the contributions done by the authors invited speakers and participation of delegates that will make WMC 2016 a very successful meeting. Special thanks to the members of the Scientific Committees that helped in the paper analysis ensuring the quality of the conference.

Welcome to the WMC 2016.

**Professor Jair Carlos Koppe**  
Congress Chairperson



## Józef Dubiński

The 24th World Mining Congress is one of the most important mining events worldwide and is going to be held in Rio de Janeiro, Brazil, from October 18 to 21, 2016. The premiere of the World Mining Congress took place 58 years ago, in September 1958, in Warsaw, Poland. Currently, the WMC organization gathers 45 mining nations from all over the world.

Each World Mining Congress, which takes place in a different host-nation, is always a great mining occasion for the international community that represents science and industry figures involved in the exploration of mineral assets. We can assert that this congress points to the most significant directions for global mining development and determines priorities for the activities of all institutions related to mineral activity. The same approach is going to be adopted during the 24th World Mining Congress, which is going to concentrate on the theme of "Mining in a World of Innovation". Nowadays, an increasing number of countries hold great knowledge potential on mining. The challenges aforementioned demand mutual cooperation, exchange of technical knowledge and professional experience, as well as assistance to those in need. Personally, I believe that our generation of the world mining society – the heirs of our illustrious ancestors – will follow their accomplishments and guide the organization of the World Mining Congress into a new direction, to assure many more years of effective services to global mining and to the people who have taken part in this challenging activity, yet still necessary for all humankind.

### **Józef Dubiński**

Professor and Doctor of Engineering

Corresponding Member PAS

Chairman of the World Mining Congress International Organizing Committee

## **HONORARY CHAIRPERSONS**

JOSÉ FERNANDO COURA  
*President-Director of the Brazilian Mining  
Association (IBRAM)*

MURILO FERREIRA  
*Chief Executive Officer of VALE*

## **SPECIAL HONOUREE**

GEOLOGIST MARCELO RIBEIRO TUNES  
*Director of Mining Affairs at the Brazilian  
Mining Association (IBRAM)  
Former General-Director of the National Department  
of Mineral Production (DNPM)*

## **CONGRESS CHAIRPERSON**

PROFESSOR JAIR CARLOS KOPPE  
*Federal University of Rio Grande do Sul (UFRGS)*

## **CONGRESS CO-CHAIRS**

PROFESSOR EDUARDO BONATES  
*Federal University of Campina Grande (UFCG)*

PROFESSOR ENRIQUE MUNARETTI  
*Federal University of Rio Grande do Sul (UFRGS)*

PROFESSOR GEORGE VALADÃO  
*Federal University of Minas Gerais (UFMG)*

PROFESSOR ISSAMU ENDO  
*Federal University of Ouro Preto (UFOP)*

PROFESSOR LUIS ENRIQUE SÁNCHEZ  
*University of São Paulo (USP)*

## **CONGRESS TECHNICAL COORDINATION**

RINALDO CÉSAR MANCIN  
*Director of Environmental Affairs at the Brazilian  
Mining Association (IBRAM)*

## **WORLD MINING CONGRESS CHAIR**

M.SC. ENG. JACEK SKIBA  
*Secretary General of the World Mining Congress*

PROF. JÓZEF DUBIŃSKI  
*World Mining Congress Chairperson and  
Managing Director of the Central Mining Institute,  
Katowice, Poland*

**NATIONAL SCIENTIFIC  
ADVISORY COMMITTEE**

AARÃO DE ANDRADE LIMA – UFCG  
ANDRÉ CARLOS SILVA – UFG  
ANDRÉ CEZAR ZINGANO – UFRGS  
ANTÔNIO EDUARDO CLARK PERES – UFMG  
ANTÔNIO PEDRO F. SOUZA – UFCG  
CARLOS HOFFMANN SAMPAIO – UFRGS  
CARLOS OTÁVIO PETTER – UFRGS  
CLÁUDIO LÚCIO L. PINTO – UFMG  
DINIZ TAMANTINI RIBEIRO – VALE  
EDMO DA CUNHA RODOVALHO – UNIFAL  
ENRIQUE MUNARETTI – UFRGS  
EUNÍRIO ZANETTI – ITV/VALE  
GÉRMAN VINUEZA – ITV/VALE  
GEORGIO DI TOMI – USP  
IVO ANDRÉ HOMRICH SCHNEIDER – UFRGS  
JOÃO FELIPE C. L. COSTA – UFRGS  
JOSÉ BAPTISTA OLIVEIRA – UFBA  
JOSÉ MARGARIDA DA SILVA – UFOP  
JULIO CESAR DE SOUZA – UFPE  
LAURINDO DE SALLES LEAL FILHO – ITV/VALE  
LINEU AZUAGA AYRES DA SILVA – USP  
LUIZ ENRIQUE SÁNCHEZ – USP  
MICHEL MELO OLIVEIRA – CEFET/ARAXÁ  
MÔNICA CARVALHO – UFPB  
PAULO SALVADORETTI – UFRGS  
RICARDO CABRAL DE AZEVEDO – USP  
ROBERTO CERRINI VILLAS-BÔAS – CETEM  
*(in memorian)*  
RODRIGO DE LEMOS PERONI – UFRGS  
VLÁDIA CRISTINA SOUZA – UFRGS  
WILSON TRIGUEIRO DE SOUZA – UFOP

**INTERNATIONAL SCIENTIFIC  
ADVISORY COMMITTEE**

ABANI R. SAMAL, PH.D  
*University of Utah, US*  
DR. ANDRE XAVIER  
*Canadian International Resources and  
Development Institute (CIRDI), Canada*  
MR. G.P. KUNDARGI  
*Chairman-cum-Managing Director,  
MOIL Limited, India*  
DR. BISWAJIT SAMANTA  
*Indian Institute of Technology, India*  
MR. M. BILGIN KAYNAR  
*Deputy Chairman Turkish National Committee, Turkey*  
PROF. DR. CARSTEN DREBENSTEDT  
*Institut für Bergbau und Spezialtiefbau, Germany*  
PH.D. DEBORAH J. SHIELDS  
*Colorado State University, US*  
PROF. DR. DOMINGO JAVIER CARVAJAL GÓMEZ  
*Universidad de Huelva, Spain*  
PROF. ERNEST BAAFI  
*The University of Wollongong, Australia*  
PROF. DR. ENG. JAN PALARSKI  
*Silesian University of Technology, Poland*  
PROF. DR. ENG. STANISŁAW PRUSEK  
*Central Mining Institute, Katowice, Poland*  
DR. FARSHAD RASHIDI-NEJAD  
*University of New South Wales, Australia*  
PROF. FERRI HASSANI  
*Mc Gill University, Canada*  
PROF. DR. FIDELIS TAWIAH SUORINENI  
*University of New South Wales, Australia*  
PROF. GIDEON CHITOMBO  
*The University of Queensland, Australia*  
DR. HUA GUO  
*Queensland Centre for Advanced Technologies  
(QCAT), Australia*  
PROF. HOOMAN ASKARI-NASAB  
*University of Alberta, Canada*  
MR.SC. IVAN COTMAN  
*KAMEN d.d. (Ltd.), Croatia*  
PROF. ING. VLADIMÍR SLIVKA  
*Technical University of Ostrava, Czech Republic*

DR. J. EFTEKHAR NEJAD  
*Semnan Taban Co.*

PROF. JOZE KORTNIK  
*University of Ljubljana, Slovenia*

DR. JUAN PABLOS VARGAS NORAMBUENA  
*Universidad de Santiago de Chile, Chile*

ASSOC. PROF. JURAJ B. DUROVE  
*Technical University of Kosice, Slovak Republic*

PROF. KEN-ICHI ITAKURA  
*Muroran Institute of Technology, Japan*

PROF. LINA MARÍA LÓPEZ SÁNCHEZ  
*Universidad Politécnica de Madrid, Spain*

PROF. DR. LEOPOLD WEBER  
*Austria*

PROF. MAREK CAŁA  
*AGH University of Science and Technology, Poland*

PROF. MARILENA CARDU  
*Politecnico de Torino, Italy*

DR. MARTIN WEDIG  
*VRB, Germany*

ASSIST. PROF. MEHMET KIZIL  
*The University of Queensland, Australia*

DR. MICHAEL KARMIS, STONIE BARKER  
*Virginia Center for Coal and Energy Research, US*

PROF. MONIKA HARDYGÓRA  
*Wroclaw University of Technology, Wroclaw, Poland*

PROF. DSC. NIKOLAY VALKANOV  
*Minstroy Holding JSC, Bulgaria*

ASSOC. PROF. DR. OSCAR JAIME RESTREPO BAENA  
*Universidad Nacional de Colombia*

ASSOC. PROF. PAUL HAGAN  
*University of New South Wales, Australia*

PROF. PAUL WORSEY  
*Missouri University of Science and Technology, US*

PROF. PETER DOWD  
*The University of Adelaide, Australia*

PROF. PETER RADZISZEWSKI  
*McGill University, Canada*

PROF. PH.D. PIOTR CZAJA  
*AGH University of Science and Technology, Krakow, Poland*

PROF. PINNADUWA KULATILAKE  
*University of Arizona, US*

PROF. SALEEM ALI  
*The University of Queensland, Australia*

ASSOC. PROF. SERKAN SAYDAM  
*University of New South Wales, Australia*

PROF. DR. SINASI ESKIKAYA  
*Istanbul Technical University, Istanbul, Turkey*

PROF. STANISŁAW WASILEWSKI  
*AGH University of Science and Technology, Poland*

ASS. PROF. TAKIS KATSABANIS  
*Queens University, Canada*

PROF. TA M. LI  
*Tetra Tech, US*

ASSIS. PROF. THOMAS OOMMEN  
*Michigan Technological University, US*

Prof. Dr. Wang Deming  
*China University of Mining and Technology, China*



## 24th World Mining Congress

MINING IN A WORLD OF INNOVATION

October 18-21, 2016 • Rio de Janeiro /RJ • Brazil

# Summary

ANALYSIS OF INTERDISCIPLINARY PRODUCTION DATA AS THE ROAD TO MODERN MINE MANAGEMENT   Leszek Borkowski	15
ANALYSIS OF NEW PROJECT DISPATCH SYSTEM IN MINING   W. S. Felsch Junior, and F. Ferrante, and A. A. Pinto, C. F. Souza	25
ELECTRONIC EXPEDITIOUS SYSTEM FOR DEPTH AND WATER EVALUATION IN BLASTING BOREHOLE   E. Munaretti and I. Pablos, R.B. Antocheviz and B.H. Schmidt, G. Geremia and M.I. Serrano	34
ENERGY AUTOMATION AND HYBRIDIZATION: INTEGRATING RENEWABLE ENERGY FOR OFF-GRID MINING   John Okoro	41
IGBT BASED HIGH POWER DRIVES FOR SALIENT-POLE SYNCHRONOUS MACHINES   Gilberto da Cunha, Paulo José Torri and Joable Andrade Alves	52
IT-OT AS A PRODUCTIVITY ENABLER IN MINING   Constantino Seixas Filho	59
LEAN SPEED OPTIMIZATION APPLIED TO A CYCLIC HAUL OPERATION   D. Rylander, J. Fryk, P. Wallin and J. Axelsson	71
MINE AUTOMATION AND IMPLEMENTATION OF INNOVATIVE TECHNOLOGY: A REVIEW IN INDIAN CONTEXT   Narendra Kumar Nanda, Shailendra Kumar	80
TELERESCUER – AN INNOVATIVE ROBOTIZED SYSTEM FOR SUPPORTING MINING RESCUERS BY INSPECTING ROADWAYS AFFECTED BY CATASTROPHES   Wojciech Moczulski, Krzysztof Cyran, Marcin Januszka, Petr Novak, Anna Timofiejczuk	93
THE CHALLENGE OF WIRELESS CONNECTIVITY TO SUPPORT INTELLIGENT MINES   V. S. B. Barbosa, and L.U. Garcia, G. Caldwell and E. P. L. Almeida , I. Rodriguez, T. B. Sørensen and P. Mogensen, H. Lima	105
THROUGH-THE-EARTH COMMUNICATIONS FOR AUTOMATION IN UNDERGROUND MINES   André N. Barreto, Leonardo Aguayo, Adoniran Judson B. Braga	117

# ANALYSIS OF INTERDISCIPLINARY PRODUCTION DATA AS THE ROAD TO MODERN MINE MANAGEMENT

\*Leszek Borkowski

*KGHM Polska Miedź S.A.  
O/ZG Polkowice-Sieroszowice  
Kaźmierzów 100  
59-101 Polkowice, Poland*

*(\*Corresponding author: [leszek.borkowski@kghm.com](mailto:leszek.borkowski@kghm.com))*



**24th World Mining Congress**

MINING IN A WORLD OF INNOVATION

October 18-21, 2016 • Rio de Janeiro /RJ • Brazil

## **ANALYSIS OF INTERDISCIPLINARY PRODUCTION DATA AS THE ROAD TO MODERN MINE MANAGEMENT**

### **ABSTRACT**

The processing ever-increasing data sets is becoming a common practice both in business and in daily life. The relationships and correlations between the data from different areas of the mine production process may prove to become an excellent source of management and maintenance information. They may also have a proactive impact on the course of the production process. The location of bottlenecks in the mining process gives a possibility to release the additional resources of organization and ability to reduce costs. The paper presents the examples of invisible everyday relationships between the data from such systems as automation, monitoring, surveillance, ERP, CMMS and the possibility of their usage in the optimization of the production process.

### **KEYWORDS**

Big Data, Internet of Things, data processing, correlation, patterns.

## **BIG DATA AS A CAPITAL IN POLISH COPPER MINING**

Recently observed development of availability to the internet network as well as development of appliances with embedded communication interface have brought about the rapid growth in amount of generated data and therefore the need of record and appropriate data processing has emerged. Internet of Things (IoT) is a conception of connecting various appliances able to communicate to the computer network. The Big Data is a notion related to modern systems of processing of huge amount of data and searching among them patterns, relations, solutions which previously were impossible to find. Both the communication of appliances which belong to the Internet of Things and the analysis of huge amount of data foreshadow revolutionary social changes and streamlining of management. The mentioned trends find a use for mining industry. Development in the fields like automation of production process, location systems, appliances equipped in communicational interface, availability of computers and mobile devices in underground conditions has brought about tremendous growth of data which has to be recorded, segregated and analysed. Analysis and management of huge amount of data are challenging due to the volume of the data, different format, the speed of generating and indicating the priorities of its significance. Effective multidisciplinary data analysis and increasing availability of on-line communication in Polish copper mines may give opportunity to treat this area as an additional resource of the organization which enables to decrease production costs, what is more, it gives a chance to innovative approach to management process. Furthermore, the data analysis which is delivered online from different production fields may enhance the peace and quality of work and to expedite response to any irregularities in the production process. Next chapter presents the selected source of data from the production and maintenance area which are generated in the KGHM mines.

## **SOURCES OF PRODUCTION AND MAINTENANCE DATA IN THE KGHM MINES**

### **Monitoring of Mining Machinery – the SYNAPSA Project**

The main reasons of implementing the SYNAPSA project in the KGHM mines were striving to maximal utilisation of mining machines and optimization of costs connected with their management. The



project includes monitoring of the mining machines in the maintenance and production fields. Current technical parameters collected in special recorders which are inbuilt into the machines are transmitted by Wi-Fi and fibre optic networks to the Business Intelligence platform where the mentioned data is combined with the data from other systems and after that the target reports are prepared. After the process the generated data shows the picture of the working day and provides a lot of diagnostic information about the engine, the driving gear and the operating systems of other parts of the machine. The collected diagnostic data includes plenty of operating parameters and allows to conduct the wide range of analysis which therefore enables failure prediction or necessity of repairing the machine.

Because of limited number of Wi-Fi access points installed in tough underground conditions the data transfer from the machines takes place only once a shift (sometimes once per 12 hours). Thus, it causes limited availability of the on-line reporting to people managing underground production. Currently, the reports about engines are available at the end of each shift. Other aggregated information is available in daily or monthly intervals. Intensive works are being conducted to expand underground Wi-Fi network. This should ensure an increase in the frequency of the data transfer from machines and thus accelerate availability of the reports to people managing underground production. The figure 1 shows the sample of production report of haul truck machine ŁK3 in the mining department G-23 in the Polkowice-Sierszowice mine.

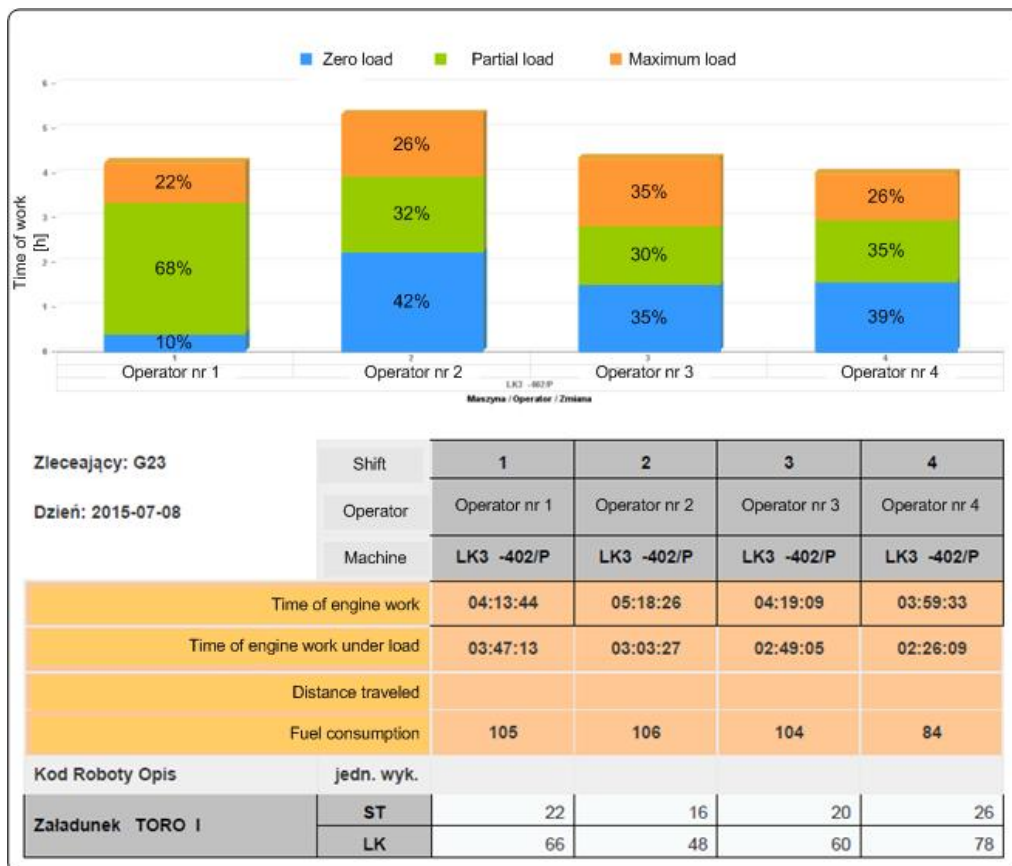

Figure 1 - Maintenance and production data from haul-track machines ŁK3

The report shows combined data from the machine recorder (time of engine work, engine speed, fuel consumption) with the data from SAP HR system (operator's ID, code of work, etc.). This is the example how the information obtained during analysis of production data may set the basis for the decisions leading to improve workflow and increase of efficiency. Moreover, the interpretation of the

diagnostic data obtained from the machines represents a way to improve technical solutions, especially in co-operation with suppliers of mining equipment. The correlation with information from other systems may help find dependents which have not been identified yet what furthermore may have essential impact on improvement in the production process.

### Maintenance Systems for Mining Machines

Implemented in mechanical department Computer Maintenance Management System CMMS is an abundant source of data related to process of maintenance mining machines. It stores the history of repaired machines, the statistics related to spare parts and all kinds of financial contributions to the maintenance. The data which is contained there constitutes the basis for analysis and looking for relations with the diagnostic data recorded in the mining machines, for example, the impact of distance between the workshop and the face area on machine failure frequency, the level of tire wear depending on the working area, failure analysis and assessment of particular machine parts or assessment of the applied technical solutions. Information collected in the CMMS system allows to perform long term analysis, however, in correlation with data from other systems it may lead to discovery of relations that haven't been known yet.

### Support System for Drilling Process

Support system for drilling process has been implemented into drilling machines which operate in G-32 mining district in the Polkowice-Sieroszowice mine. The figure 2 shows production report of a drilling face.

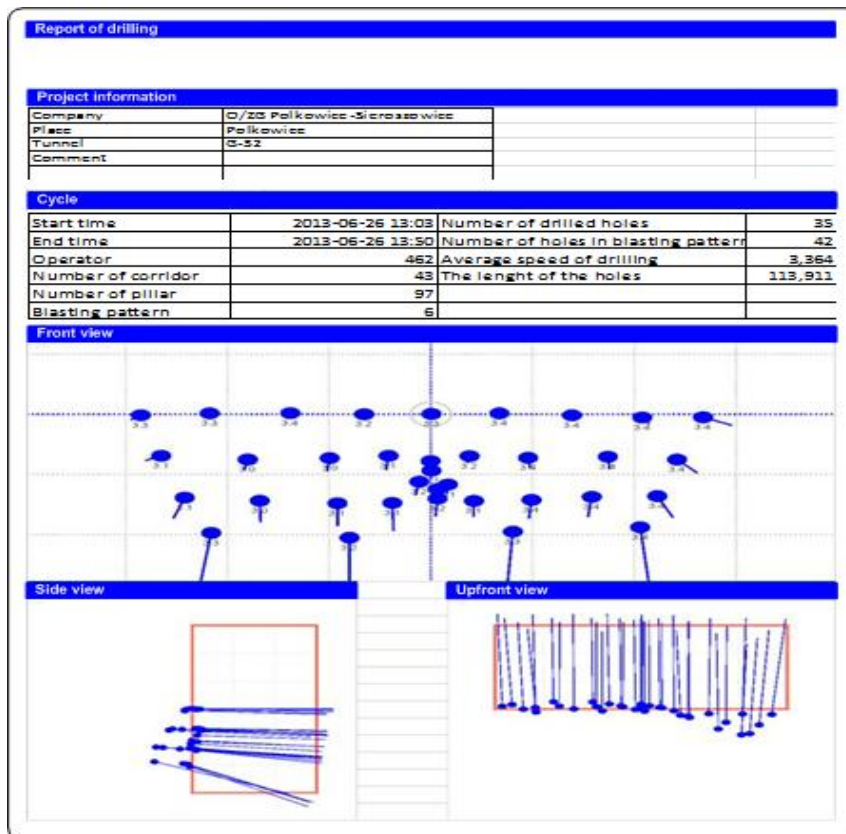

Figure 2 - Production report of a drilling face

It facilitates proper performance of the holes during the drilling process through the usage of electronic blasting patterns. It increases precision of drilling, ensures process repeatability and then automatic operations. Deployment of the support system has considerably influenced improvement of the drilling process in G-32 mining district by increasing an average cutting depth about 0,4 m.

From the data point of view the system is a source of accurate information about drilling process and characteristics of the drilling machine. The data generated in this system should be treated as an additional potential for utilization. Wireless data transmission from the support system for drilling process, which is planned to be used in the future, will ensure easy access of information for people who manage production directly and it will enable analysis and correlation with data from other systems.

**Systems of Machines and People Localization in Mining Drafts**

Currently carried out pilot implementation of locations systems for machines and people is an extension of the work within SYNAPSA project. The tested solutions are based on a system of gates identifying the moving machines and workers. The data generated in location system enables identification of machine presence in the area between the installed gates. Analysis and processing of the data enable presentation of parameters such as the machine presence time in workshop, the time of arrival to the mining district, time of presence in mining area or number of visits at a dump station. The figure 3 shows an example of report of the machine operation.

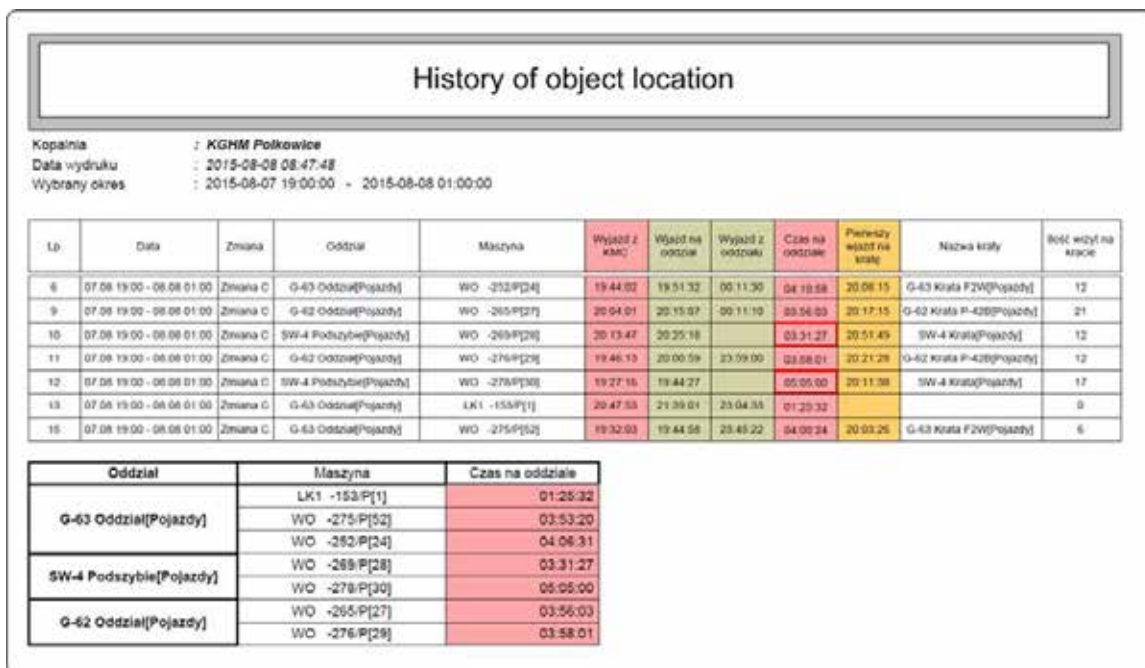

Figure 3 - Shift report of load & haul machines from localisation system

The report presents very accurate time analysis of working shift for each machine. This is an excellent management tool and objective source of information for the machine operators. Moreover, it is an interesting benchmark of utilisation enhancement for mining machines. Analysis of data from location system in correlation with maintenance data from mining machines, ventilation data or data from monitoring of electrical systems may contribute to the development of optimal solutions in all these areas.

### SCADA Systems – Monitoring and Visualization of Production Process

The SCADA systems of monitoring and visualization are the oldest and currently the biggest source of data collected on-line in the mining divisions of KGHM Polska Miedź S.A. They provide monitoring and visualization of most production process areas where stationary equipment and machinery are used i.e. hoists in shafts, system of conveyor belts, main and district drainage pumps, stations of main ventilation fans, air conditioning system, system of the ore transport on the surface and others. Continuous modernization of the mentioned systems as well as application of newer and newer sensors of physical or environmental parameters which enable the usage of reliable communication systems and progressive algorithms have effected in obtaining a very accurate picture of operating status of mining machines and equipment, both from maintenance and production point of view. The figure 4 shows collected on-line production and diagnostic data of a conveyor belt.

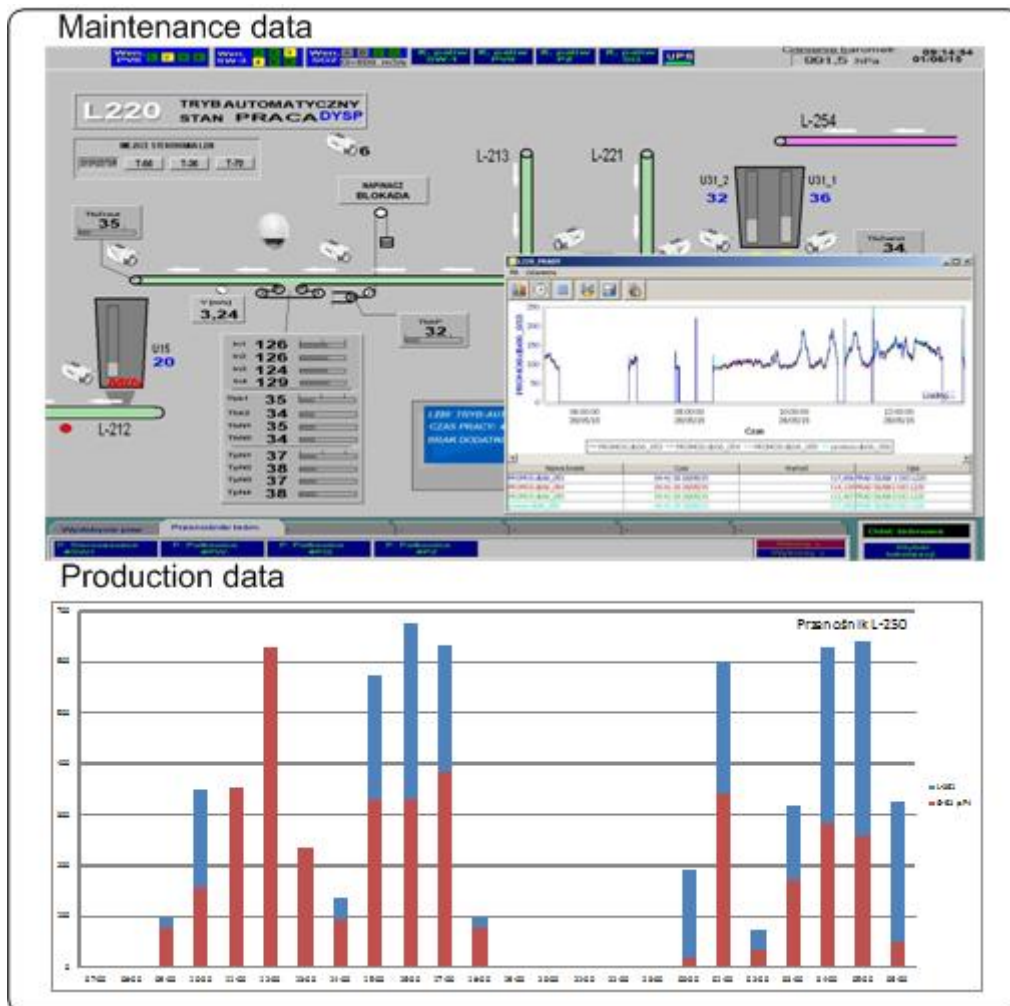

Figure 4 - Maintenance and production data of conveyor belt

The mentioned data reflects very exactly the current operation status of conveyor belt enabling quick diagnosis and response to failures or irregularities. The on-line data collecting by using the Ethernet protocol is crucial. Continuous analysis of data from sensors and tracking trends among this data can help in prediction of failure status and more proactive approach to maintenance of machines and equipment.

The on-line data collecting aids in fast processing and searching for correlations with data from other systems in order to find patterns which may ensure solutions to problems, location of production bottlenecks or low efficiency in the production process. Comparing and correlation of the mentioned data with data from other systems like hoist systems, electricity systems or e-Raport (a system of production reporting) may lead to discovery of data patterns or relations which have been previously unknown. This could improve efficiency, increase of production or decrease of costs.

### **Underground Video Surveillance Systems**

The use of the digital IP cameras and the development of wideband transmission networks have been the main factor for the expansion of the underground video surveillance system in mining divisions of KGHM Polska Miedź S.A. The image from the cameras available in the selected locations of the mine significantly improves the control of each part in production processes. What is more, it generates relevant information in case the immediate decision is to be taken by people who manage directly the production, dispatchers as well as the managing staff. The role of video surveillance systems is essential for improving security in the underground condition both in the usual works and in case of accidents when a rescue operation is being conducted.

The data collected in the video monitoring system is an excellent resource for analysis and search for the solutions which enable keeping the production process up-to-date. The recently observed advancement of video analytics algorithm creates a promising prospect of using the data for identifying particular situations i.e. identification of waste elements which are transported together with the output on the conveyor belt, identification of people especially in dangerous areas, enhancement of automation capabilities, etc. Currently in the Polkowice-Sieroszowice mine is being conducted the third phase of the development of the remote controlled dump stations. The aim of this project is a stand-alone operation of a hammer crushing the ore which is, for now, remotely controlled by operators. The already recorded history of its work is a priceless source of information for creating algorithms for the stand-alone hammer operations. The integration of the video surveillance system with other systems used in the mines turns into a huge development potential which is able to provide significant and essential information for the people managing the production.

### **Control Systems of Electrical Network**

Electricity is the basis of the production process in mining divisions of KGHM Polska Miedź S.A. Delivering of energy in such a vast area and in such extremely tough environmental conditions is a great challenge and requires a huge number of devices for distributing the energy. Effective management of these devices transfers directly on the results of extraction, transportation of excavated material or other parts of the production process.

Therefore in the Polkowice-Sieroszowice mine there has been started the installation of the control system for a low voltage electrical network. The aim of this project is possibility of on-line, remote monitoring and control of underground power substations. It will help in reduction of power outages caused by failures and will enable more flexible management of the power supply network. Currently in the Polkowice-Sieroszowice mine more than 400 power substations are being operated. The data recorded in the system will allow the electrical service to access the information about each drains of the power substations, the value of each current, the measurement of energy consumption and additional features which diagnose errors, failures and damage. The mentioned above information available on the underground computers will enable electrical service to take quick and accurate decisions which will improve efficiency of power supply process. The possibility of interdisciplinary data analysis in correlation with data from mining machines, conveyors or location systems is an added value which may be used to specify a variety of key performance indicators:

- for conveyors – the amount of transported ore vs. energy consumption,

- the determination of costs of electricity used for the drilling and bolting process in a particular mining department,
- the determination of the optimal amount of drilling (bolting) machines in a production area in terms of power supply parameters.

On-line availability of the data obtained from the control system of low voltage electrical network and possibility of using them in a variety of analysis may contribute in many fields of production process.

### **Security Systems**

The security systems in the polish copper mines contain data from seismic, ventilation, air-conditioning, telecommunication and alarm-broadcasting systems. In terms of safety the mentioned above data describes the whole underground mining area. Thus, the data is very close related with each machine, appliance and system exploited in the area. The analysis of the data with relations with the data from other systems may bring interesting observations and contribute to finding solutions to the current difficulties. One example is the multitude relations with ventilation system in the mine. Tracking the correlation between the amount of machines working in mining department and the operation of additional fans installed in order to ventilate drafts may help find the optimal solution and reduce the costs of the ventilation i.e. by periodic switching off (between shifts) some of the fans installed in the mining department.

However, the answer to this question resides into the analysis of interdisciplinary data already collected in the mentioned systems. Therefore, the gathered information is the additional resource for the company which is waiting for the proper use. The only investment is creation of an appropriate data analysis system which will be able to utilize this additional resource for the benefit of the company.

### **e-Raport System**

The e-Report implemented in the Polkowice-Sieroszowice mine ensures electronic reporting of work done by the underground computers. It greatly improves the flow of information between the cooperating departments and the integration with the SAP system enables automation of some reporting operations. The data gathered in the e-Raport system contains a precise description of the performed works, moreover, it has connections between working people and the working equipment. Additionally, it is available in real time what has the fundamental impact on the speed of communication and decision-making. The e-Raport system which utilizes the well-developed transmission infrastructure may form a basis for integration of data from other systems used in the production process.

## **DATA CORRELATION, PRESENTATION OF THE RESULTS AND REAL TIME DECISION MAKING**

### **Connections and Correlations of Data**

The amount of the collected data in the presently working production and maintenance systems in the Polkowice-Sieroszowice mine is huge and the nearest future foreshadows further growth. Investments in the individual systems have had its business case and aimed at implementing new solutions, improving safety or optimizing the production. Those goals have been achieved and all the expenditures are fully justified. The side effect of introducing of these systems is continuous generation of the production or maintenance data which is recorded into different databases. It is the added value of the above mentioned projects and it should become the area of exploration in search for modern and innovative solutions both technological and managerial ones.

The prerequisite for finding new patterns, relations or connections between the individual elements of the production process is the interdisciplinary analysis of this data. Only that kind of analysis has the biggest chance to find “new” things which were previously inaccessible because of insufficient

amount of the data. The way forward seems to be the Big Data analysis and appropriate database systems enabling fast and multi-layered data processing. If only the data presented in the previous section were integrated we would get the following picture of the situation for the drilling machine:

- location data – accurate time of machine presence in a mining division with the exact time of entry and exit,
- data from the monitoring of mining machines – accurate information of the travelled distance, fuel consumption, parameters of an operating engine and additional equipment, parameters of an electric engine,
- data from the support system of drilling process – the amount and quality of drilled holes, compatibility with blasting patterns, the amount of rock faces prepared to blasting,
- data from the control system of electrical network – real time information about the availability of power supply or its lack and the parameters of power supply,
- data from the e-Raport system – the direct linkage of a worker with the machine, the exact area of the drilling process.

As the previous examples show a comprehensive picture of the done work by a worker and by the machine becomes available and visible. For the people directly managing the production it may be an excellent tool for efficiency improvement. It should be emphasized that providing the comprehensive information to an employee performing the work may also motivate them to improve their abilities. Daily availability of performance indicator which describes the quality of drilling process i.e.: percent of compliance of drilled holes with blasting patterns may assure objective assessment of an operator's work. Furthermore it may enable improvement of their skills due to awareness of quality of the performed work.

### **User's Interface and On-Line Communication**

Displaying the information to its users must be strictly customized to their needs. The user interface should provide the appropriate level of details and at the same time should present only relevant information. An attractive, functional, intuitive control panel gives additional hope to motivate the user to look for new areas for analysis. Customization of the control panels for each managing level of the organization seems to be a necessity. It requires a lot of work but provides the high level of using the information presented there.

Fundamental importance for introducing the changes into the production process has a strategy of aggregation and data delivery. The biggest influence on the changes into the production process have people directly managing the production, thus from the information point of view they are the most important objects. The greatest opportunities gives the real time on-line communication which enables the use of underground computers or mobile devices as access tools to customized reports. Information about the course of a shift production and comparing it to the already adopted plan gives the opportunity for an immediate response to the process and for taking aware decisions supported by reliable data.

If the data from SCADA systems, monitoring of mining machines, location systems, geological systems or production plan systems is combined and processed it may generate control panels tailored to the needs of the users. The panels contain information which are needed to make the right decisions in the fields like production, maintenance or safety. In this way in the middle of the production shift it becomes possible to take decisions like: moving mining machine to another mining division because of electrical failure, finding the reasons for the decline of ore quality or finding the reasons of downtime of machines and devices.

### **Implementing Changes Based on the Data**

The main factor of the success of implementing changes based on the data is providing the right information to the right people in the right time. The processing of huge amount of data and communication between different systems is not an end in itself. Finding the right patterns, relationships,

data correlation is only the first step towards improvement of the efficiency of the production or maintenance process. It is necessary to perform the second step – making the decision inducing an appropriate action based on the provided information.

Crucial for the effectiveness of change and the process of continuous improvement is the selection of performance indicators KPI which are assigned to the individuals. These people should have real possibilities for taking actions related to the information already provided otherwise this information will only raise the frustration resulting from the lack of impact on the particular area.

Gathering huge amount of data in the real time only makes sense if the resulting from it decisions will be made in the real time. Taking appropriate actions at the right time and place on the basis of the indicators guarantees the positive introduction of changes and improvements in production, maintenance or safety systems. The development of underground communication systems, extension of data processing systems and creation of one common control room in the Polkowice-Sieroszowice mine represent milestones on the way to the exploration of additional resource of the mine which is the collected data.



# ANALYSIS OF NEW PROJECT DISPATCH SYSTEM IN MINING

\*W. S. Felsch Junior<sup>1,2</sup> and F. Ferrante<sup>1,2</sup> and A. A. Pinto<sup>1</sup>, C. F. Souza<sup>3</sup>

<sup>1</sup> *CSN Mineração  
Mina Casa de Pedra  
Congonhas/MG, Brazil  
(\* Corresponding author: [walter.felsch@csn.com.br](mailto:walter.felsch@csn.com.br))*

<sup>2</sup> *Universidade Federal de Ouro Preto- UFOP  
Campus Morro do Cruzeiro  
Ouro Preto/MG, Brazil*

<sup>3</sup> *Universidade Presidente Antonio Carlos  
920 Padre Teófilo Reyn Street  
Conselheiro Lafaiete/MG, Brazil*



**24th World Mining Congress**  
MINING IN A WORLD OF INNOVATION  
October 18-21, 2016 • Rio de Janeiro /RJ • Brazil

## ANALYSIS OF NEW PROJECT DISPATCH SYSTEM IN MINING

### ABSTRACT

The demand on increasing competitiveness, associated to the adoption of new knowledge and technologies, are points present in companies and organizations of all segments. In the specific case of mining, productivity gain and costs reductions need specific solutions, usually developed for harsh conditioned environments that are not found in other kind of business. Applications in Brazil involving the use of GPS technology in fleet control exists in mining since the decade of 1990, but each implantation shows its adaptation challenges to operating conditions. Several factors influence the success of the adoption of new systems such as the conceiving of the changing project, operational maturity, the engagement of the direct leadership and participation of the top management. The main goal of this study is to present the implementation of a Dispatch System in a mine located in the Brazil's "Quadrilátero Ferrífero" area. It will be presented in this study the main points that impacted the implementation of the new technology, and a performance analysis before and after the system installation, by comparing the impacts on the outcome of the operation. During the first six months of operation, it is estimated a gain of more than 13% in the productive performance of the transportation fleet. These gains increased over the years, expanding the possibilities of the system's usage. This shows that the assimilation of a dispatch system that changes the operational culture is simpler than the factors initially considered, and provide superior gains compared to the ones set in its viability.

### KEYWORDS

Dispatch System, Performance Analysis, Productivity Rate

### INTRODUCTION

The mining industry has shown strong growth as the global demand for minerals and metals reaches higher levels. Automation has played a key role in the production process and improve operational performance in mining companies, with increasingly present technologies in the work routine of the technical teams. The aim of this paper is to present the case study on the implementation of a fleet management system, also known as electronic order in a mine located in the region named Quadrilátero Ferrífero, central part of the state of Minas Gerais, analyzing data from operational indicators obtained from the use of an automated fleet allocation compared to manual control production. A survey of historical data for the period prior to implementation of the dispatch system was made in order to compare with the information generated in the post-implementation period. Production systems manual control portray a practice of truck dispatching in which the technician responsible for the equipment direction control, is located in a strategic mine point, makes decisions based on the situation analyzed in your field of vision and also based in your experience and sends the instructions to the operators of cargo transport equipment and radio.

Operators use pen and paper for note of trips (cargo flows and transport), and this information is then sent to realization of production through manual control spreadsheets. After the implementation of the dispatch system, the same indicators were analyzed using the information contained in the database that integrates the system in order to confront the information manually raised at the beginning of the program's operation. With the processing of these data revealed that there was a significant gain in the productive performance of the equipment in the first few months after system deployment. These gains have risen gradually over the years showing the assimilation of the software

within the production process. Tu and Hucka (1985) claim that has been observed improvement in 3% to 15% on transport productivity for trucks in the operations of mines that have implemented computer systems dispatch. Automated dispatch systems were introduced in the market from the end of the 70's. These systems have the ability to directly allocate the truck to a task, overcoming limitations imposed by manual operation of the process (handling a large volume of information in small space of time, difficulties to analyze the current situation and take effective allocation decisions) (Munirathinam & Yingling, 1994).

According to Felsch Jr., W. S. (2014) a well planned and implemented dispatch system can generate good savings for the mining companies. Showing up the main objective of the computerized order to maximize uptime at the mine, thus minimizing the number of trucks needed for transport, increasing the production of load equipment by reducing idleness and meeting the quality standards of the plant processing. According to Mendes (2013), inadequate decision may compromise the quality of the ore produced, or decrease the productivity of the various equipment, incurring lost productivity.

## EXPERIMENTAL

This study used actual data production notes performed manually (fill daily part by operators) and data generated through the database of the dispatch system of loading and transportation equipment mine under study. The methodology and data analysis will be presented, comparing the two forms of pointing observed:

### Data collection for specific periods:

In order to verify the variations in production indicators, data were collected relating to three distinct periods of operation, as illustrated in Figure 1:

- First Period: (FEBRUARY/2009 to JULY/2012): Absence of the dispatch system (Pointing Manual);
- Second Period (AUGUST/2012 to SEPTEMBER/2014): Dispatch system implementation period (period of adaptation and system development)
- Third Period (OCTOBER/2014 a OCTOBER/2015): Effective use of the dispatch system (Performance Management period);

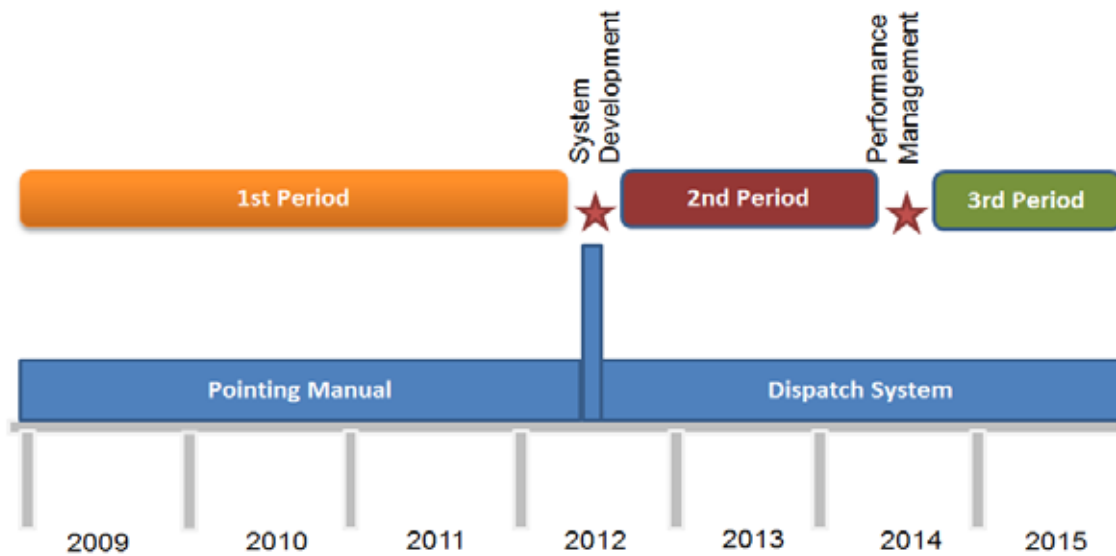

Figure 1 - Mining operating history highlighting the different periods analyzed at work

Data for the 1st period of analysis were taken from tables created in EXCEL format, filled manually by technicians responsible for mine production. For the 2nd and 3rd periods, the data were taken from reports created through consultations with the order system database. The indicators analyzed were:

- Total fleet transportation (tons)
- Average distance transportation (km)
- Number of equipment (load and transport)
- Travel number performed,
- Effective time of equipment operation (hours);
- Effective transport productivity (t / h);

## ENGINEERING DESIGN

### Indicator Productive Performance

Considering a real situation in a mine mining process is possible to list the variable "productivity" as the most important indicator to measure the production process. The effective productivity has strong linear correlation with the average distance of the trucks transport (ADT). As productivity varies as a function of time and its own behavior associated with variation of other variables associated with the mining process, it is possible to say that this random variable has a

behavior similar to a continuous stochastic process. Thus, it is possible to build a function (equation) where the productivity of a process, or part of it, may be the study variable.

For better comparison criteria between the mentioned periods, it was created an analytical indicator of the transport fleet called "Productive Performance ". This indicator is obtained by the ratio between the effective productivity of the fleet with their respective average distance of transport.

To validate the indicator Productive Performance as analysis criterion was found the correlation between the indicators that compose it. The correlation analysis provides a number between -1 and 1, which shows how two variables vary together. A positive linear correlation indicates that the two variables move in the same direction and the relationship is stronger the more the correlation is close to one. A negative linear correlation indicates that the two variables move in opposite directions and that the relationship also gets stronger the closer to -1 achieve the correlation value.

Segundo Charnet (2008) – apud Rodovalho (2013), equations obtained above 75% correlations are classified as satisfactory.

Comparing the relevant data from July 2010 to July 2014, on a monthly basis, there was a linear correlation -86.02% between the effective productivity of transport equipment and the average distance of transport. Figure 2 shows this analysis proves that the indicator "Productive Performance" as the parameter avaiation.

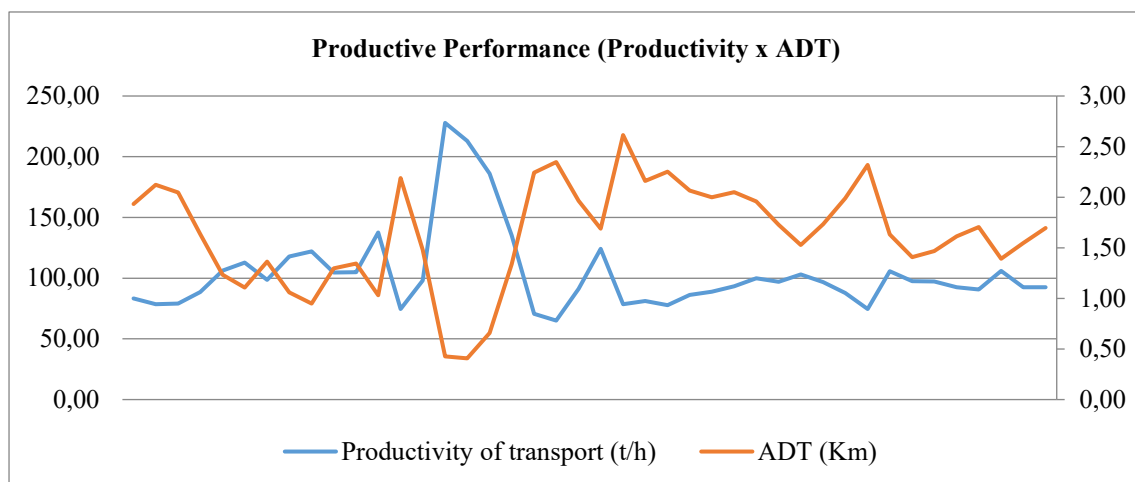

Figure 2 - Comparison between monthly productivity of transport and ADT (Correlation -86.02%)

### Operational Performance Management

Performance evaluation is critical to be made in the existing gap in the team's behavior between the performance expectations set with the organization and its actual performance.

Antoniolli (2003) says that the need for increasingly effective performance management has driven companies to develop ways to monitor and evaluate their performance.

Oliveira e Leal Júnior (2005) claim that the performance assessment tool should provide subsidies for comparing various information databases and should reflect the real picture of the

situation, making it possible to identify the strengths of management, as well as the weaknesses deserving of greater attention.

The performance management aims to diagnose and analyze the performance of the operating teams, generating insightful actions in identifying low-income and good operating practices reasons. It also provides the administration of human resources information for decision-making on salaries, merit, bonuses, promotions, layoffs, training and career planning, providing growth and development of the evaluated employee. From November 2014, early in the third period, it was introduced a performance management control of traffic control teams. Monitoring indicators were created with specific goals. The indicators analyzed are:

- Queue loading and dumping;
- Queue in supply;
- Effective load Productivity;
- Correlation full kilometer / kilometer empty

Figure 3 shows the evolution of the indicator queue (loading and dumping) during the year 2015.

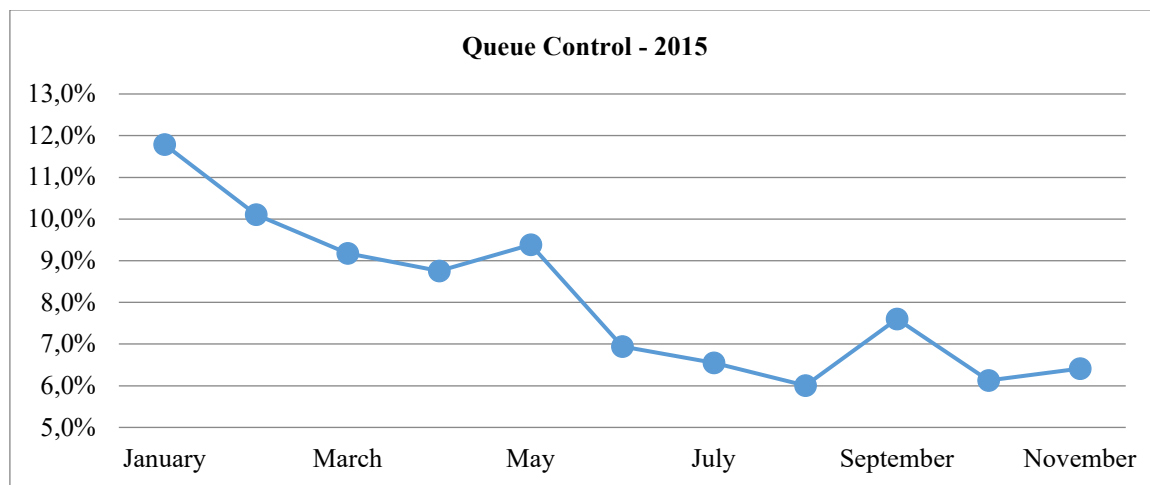

Figure 3 - Evolution of the indicator lines in 2015

## OPERATION RESULTS

With the implementation of the dispatch system yielded a gain of 13.68% in the Productive Performance of transport equipment within the first six months of using the software, compared to the historical average of the years prior to system use.

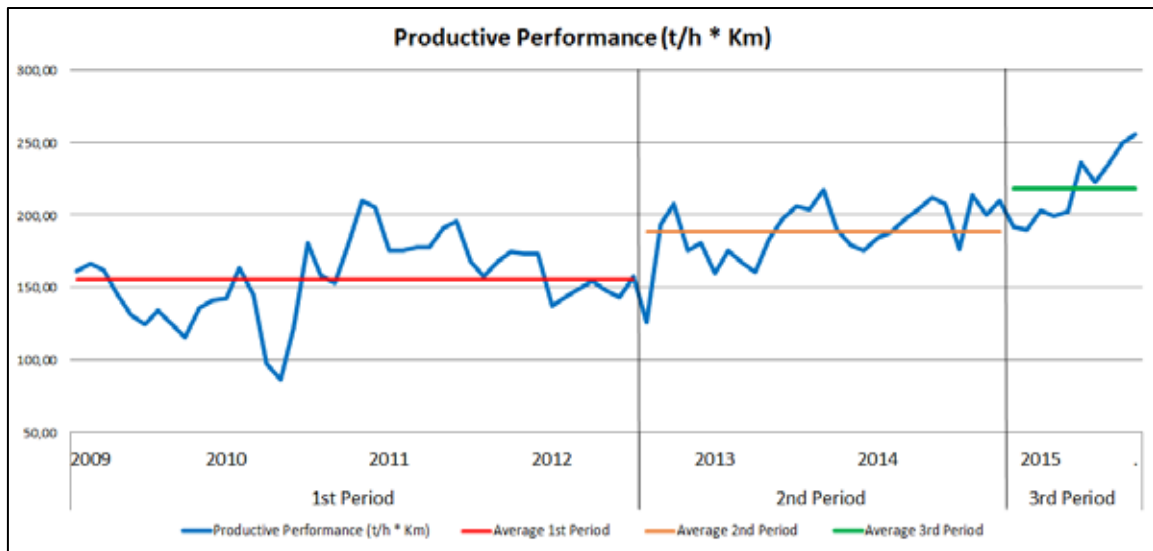

Figure 4 - Historical analysis indicator Productive Performance highlighting the averages of each period

This gain in Productive Performance remained in constant growth in the following months, with increasing experience and system assimilation showing a gain of 21.4% in the second period compared to the first and 15.9% in the comparison between the second and the third periods.

Table 1 illustrates the results and earnings for each reporting period:

Table 1 - Result indicator Productive Performance

	Productive Performance (t/h * Km)	Δ (%)
1st Period	155,23	
2nd Period	188,38	21,4%
3rd Period	218,24	15,9%

## DISCUSSION

Significant improvements in information technology has led to the mining industry to develop many decision-making models to assist in better allocation of transport equipment in opencast mines.

The main function of dispatch system is to maximize the productive time related to mine equipment, minimize the number of trucks needed for transport, maximizing the production of load equipment by reducing idleness and queues at loading, and meet the quality standards of the processing plant.

Dispatch systems can reduce operating costs by reducing the required transport fleet to meet production goals by increasing the use of the fleet and reduction in empty truck trips events.

## CONCLUSION

The objective of this study was to quantify the gains through the indicator Productive Performance, comparing the manual operating system (daily part of filling), and the automated electronic dispatch, which showed excellent results. The indicator is formed by the relationship between the effective transport productivity and average transport distance, reaching a correlation of data 86.02%, demonstrating the adherence of the data obtained during the work.

Analysis of the Productive Performance between the period before and after the implementation of the electronic dispatch system shows that there was a significant gain in performance of the transport fleet, up from 13% just in the first six months of use. And with the passage of time and increased operational maturity these gains were constantly increasing, showing that when greater assimilation of the system within the larger process will also be the possibility of gains and cost savings, further enhancing the company's competitiveness within the marketplace.

With the use of a dispatch system, it was also possible to eliminate the use of paper, changing the filling of manual pointing chips, also known as a daily part of the electronic note, so with electronically stored data can generate reports real-time production, assisting in new decision-making during the shift.

## REFERENCES

- ANTONIOLLI, P. D. (2003). Medidas de Desempenho em Gerenciamento da Cadeia de Suprimentos. Anais do XXIII Encontro Nacional de Engenharia de Produção, Ouro Preto, Minas Gerais: ABEPRO
- FELSCH JR., W. S. (2014). *Análise do Desempenho dos Operadores de Equipamentos de Mina e Simulação de Cenários Futuros de Lavra - Estudo de Caso – (Mina Casa de Pedra – Congonhas/MG)* (Pág. 12 e 13). Escola de Minas da Universidade Federal de Ouro Preto – Departamento de Engenharia de Minas - Ouro Preto – MG, Fevereiro de 2014 - Programa de Pós-Graduação em Engenharia Mineral – PPGEM
- MENDES, J. B. (2013). *Uma Abordagem Multiobjetivo para o Problema de Despacho de Caminhões em Minas a Céu Aberto* (Pág. 1 e 24). Universidade Federal de Minas Gerais – UFMG - Belo Horizonte - MG, Novembro de 2013 - Programa de Pós-Graduação em Engenharia Elétrica – PPGEE



MUNIRATHINAN, M., YINGLING, J. C. (1994). A review of computer-based truck dispatching strategies of surface mining operations. *International Journal of Surface Mining, Reclamation and Environment*, 8(1), 1-15.

OLIVEIRA, L. F. R., LEAL JUNIOR, I. C. (2009). Programa de Adoção de Empresas Terceirizadas na Cadeia de Suprimentos Fundamentado no Conceito de Ecoeficiência – O Caso do Transporte Rodoviário de Carga da CSN. XI Encontro Nacional de Gestão Empresarial e Meio Ambiente, Fortaleza, CE.

RODOVALHO, E. C. (2013). *Aplicações de ferramentas de simulação em operações mineiras para determinação de índices operacionais utilizados em planos de lavra adaptados ao estudo de caso da Mineração Casa de Pedra – CSN*. Dissertação de Mestrado, Programa de Pós-Graduação em Engenharia Mineral, Universidade Federal de Ouro Preto. Ouro Preto, Brasil.

TU, J. H., HUCKA, V. J. (1985). *Analysis of open pit truck haulage system by use of a computer model*. *CIM bulletin*, 78:879, p. 53-59.

# ELECTRONIC EXPEDITIOUS SYSTEM FOR DEPTH AND WATER EVALUATION IN BLASTING BOREHOLE

E. Munaretti<sup>1</sup> and I. Pablos<sup>1</sup>, R.B. Antocheviz<sup>2</sup> and \*B.H. Schmidt<sup>2</sup>, G. Geremia<sup>3</sup> and M.I. Serrano<sup>3</sup>

<sup>1</sup>*Demin, UFRGS  
Av. Bento Gonçalves, 9500, B75, 118  
91501-570, Porto Alegre, RS, Brazil*

<sup>2</sup>*Nitro Demolição Ltda.  
R. Dr. Pereira da Cunha, 525  
91530-290, Porto Alegre, RS, Brazil  
(Corresponding author: brunorepers@gmail.com)*

<sup>3</sup>*Instor – Projetos e Robótica Ltda.  
R. Dr. Pereira da Cunha, 525  
91530-290, Porto Alegre, RS, Brazil*



**24th World Mining Congress**

MINING IN A WORLD OF INNOVATION

October 18-21, 2016 • Rio de Janeiro /RJ • Brazil

## **ELECTRONIC EXPEDITIOUS SYSTEM FOR DEPTH AND WATER EVALUATION IN BLASTING BOREHOLE**

### **ABSTRACT**

Rock blasting is one of the most important activities for mining and, can be considered the beginning of the entire comminution process. For a blasting operation, the drilling is as important as the application of explosive charges, because, the correct spatial location of charges inside the hole is critical for power to be effectively used in fragmentation. For most miners, accurate depth of hole and height of water column information are valuable and help ensure the correct amount of explosives to be applied and also, how the hole will be loaded. This information is rarely obtained, and when this occurs, it is imprecise. For such activity, quick and reliable information is necessary, from this motivation, a system was designed that allows the evaluation of these basic parameters and, thus, quickly decide changes to the initial blasting plan in order to adapt to the conditions of water and hole depth with precision. This paper presents equipment capable of making this assessment, being portable for use by the blaster in the field, prior to loading and, consisting of a probe inserted into the blasthole containing two sensors: a humidity and an end limit switch. When inserting the probe into the blasthole, it is possible to measure the depth that the humidity sensor is triggered and the depth by the end limit switch when it is triggered. Using an encoder reading, it is possible to show quickly and accurately the information to the blaster via mobile app or tablet, so that, the operator makes the decision expeditiously and accurately, thereby optimizing the blasting operation.

### **KEYWORDS**

Blasting, Dewatering, Instrumentation, Automation, Sensors.

### **INTRODUCTION**

Rock blasting is one of the most important activities within the mineral extraction cycle, as the results obtained in this step will reflect in all subsequent stages of the comminution process. The decisions made on reliable data is a necessity for any process; however, for rock blasting it is even more necessary given its importance in production, complexities, and its associated risks.

Once the blast design is determined, the borehole locations are marked and the drill rig is brought in to drill the holes. After the drilling is finished, the next process is to load the boreholes with explosives. First, detonators are placed in every hole. These detonators are the primary elements used to initiate the explosives in a timing sequence. Next, the holes are loaded with the explosives until the stemming area limit. After stemming, the next step is to connect the detonators and finally secure the blast area to finally detonate the blast.

Explosives loading has a critical importance. The blast design should provide the correct amount of explosive for the burden. The blaster must control mass and volume of explosive material used and conduct constant checks, such as density for emulsion, the volume of explosive delivered to the borehole, diameter changes, and finally the depth of each hole and amount of water. Those measurements are critical in controlling the quality of the blast (Hopler, 1998).

The correct selection of the explosives type is a main factor that significantly affects the rock blasting operation. There are two types of explosive often used, ANFO (Ammonium Nitrate and Fuel Oil) and emulsion, selected based on cost-benefit and local environmental factors, mainly the presence or not of water in the borehole. The explosive agent named ANFO still has the lowest cost and high

energy, but may fail or deflagrate if there is water in the borehole, because ammonium nitrate is a highly hygroscopic artificial salt (Munaretti, 2002). In Brazil for small diameter holes, if there is a significant presence of water, the borehole is loaded with emulsion cartridges, an explosive agent that was developed to provide a performance similar to ANFO, but with the advantage of offering greater resistance to attack by water.

When emulsion cartridges are used, you must take into account that water column height in the borehole will increase by introducing the cartridges. López Jimeno et al. (2003) estimate the final height of the water with emulsion cartridges with the following equation:

$$H_f = (H_0 \cdot D^2) / (D^2 - d^2) \quad (1)$$

$H_f$ : Final height of water (m)

$H_0$ : Initial height of water (m)

$D$ : Borehole diameter (m)

$d$ : Emulsion cartridge diameter (m)

Common procedures for checking the presence of water in a certain borehole, immediately before loading, to decide between ANFO and emulsion, are still outdated. Usually there are three options for a blaster before choosing the explosive loading between ANFO and Emulsion (Dick et al., 2001):

- a) Throw a small stone inside the borehole and hear the noise for water or absence of, which is inaccurate and indicates the presence of water in the borehole and not the height of the water column;
- b) Visually check with the tamping pole and marking the height of the water, containing obvious limitations of depth;
- c) Using a weighted tape to mark the column height of water, which is difficult to register.

Since the introduction of ANFO in the 1960s, blasters have been searching for procedures to minimize the water inside the boreholes and use the maximum amount of ANFO, the lowest cost and effective blasting agent available. After noting the presence of water, it is common to choose to "blow" the borehole with a compressed air long steel tube, or worse, simply load partially with packed emulsion and then finish with ANFO without having any information about water level. The use of polyethylene borehole liners is another alternative to improve the use of ANFO in wet holes, however, it is time consuming for loading and offers several problems such as a high amount of water pressing the borehole walls and cuts or breaks in the liner that allow a complete fail in ANFO.

There is another procedure, to dewater the blast holes prior to loading using hydraulically driven submersible pumps. This is a popular method in some countries and an effective procedure of achieving productivity. Pilshaw (1988) shows a comparison between a borehole completely dewatered and loaded with ANFO, a borehole with cartridges and ANFO, a borehole loaded with Heavy ANFO (blend) and a borehole loaded with straight emulsion, demonstrating the viability of dewatering to reduce primary blasting costs. Figure 1 shows the four alternatives with the amount of explosives (lb) and the borehole explosive cost. From left to right side, the first borehole was dewatered and loaded with 1310 lb of bulk ANFO at a cost of US\$ 92. If the same hole were loaded with packaged emulsion, it would require 900 lb plus 425 lb of ANFO or a total of 1325 lb. at a cost of US\$255.00. Loading a 50/50 blend of ANFO and emulsion (Heavy ANFO) would result in 1825 lb and cost \$292.00. Finally loading the entire hole with bulk emulsion consumes 1960 lb at a cost of \$431.00.

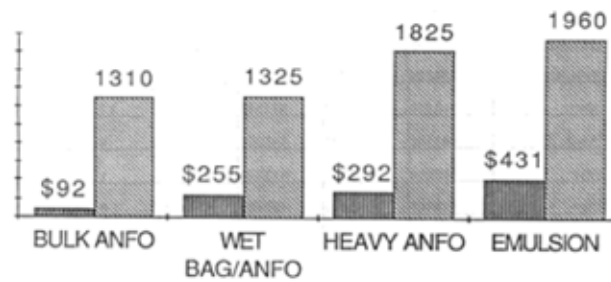

Figure 1 – Cost of four wet hole loading alternatives, after Pilshaw (1988)

However, in Brazil for most blasting operations, the blasters simply do not use dewatering because of small diameter holes, high acquisition costs and abrasive mud or debris in the boreholes. Usually, most blasters adopt a safety measure against a possible deflagration of ANFO, just simply loading the entire hole with emulsion, even if the amount of water is minimal. That means high costs as emulsion is often more expensive for small diameter holes.

When replacing ANFO by more expensive water resistant explosives, it is usually more costly and may also result in a muckpile unacceptable to a productivity-oriented operation. Assuming that the blast was designed for the use of ANFO as the primary explosive product, any deviation that precludes the use of any amount of ANFO increases the cost of all subsequent stages of the project, such as loading and hauling. Thus, it can be concluded that the ideal method for blasting in the presence of water would be dewatering. If it is not possible, and the presence of water is not excessive, the combined use of ANFO and emulsion cartridges is an effective solution. A device capable of quickly providing information about the presence or absence of water and the water column level in the borehole is then necessary.

After studying a low cost and practical solution, the authors manufactured some low-cost equipment, easy to use and quick to report to the blaster about the presence and the height of the water column. Figure 2 shows the work carried out in simple stages; the project idealization, second, equipment design and manufacture; third, laboratory tests; and, finally, fieldwork (in progress).



Figure 2 – Work schedule

### EQUIPMENT DESCRIPTION

Equipment was developed to evaluate the water column level in boreholes. It is composed of two systems in a probe, one to detect the presence of water and the other for detecting the borehole bottom. Both systems have inductive sensors that act by moving the mechanical parts (Figure 3).



Figure 3 – The borehole probe

The water level detection system consists of a buoy that floats vertically upward after having contact with the water in the borehole, activating the inductive sensor and indicating the water level (Figure 4b). The bottom borehole detection system is constituted by a metal tip, which also moves vertically in the probe. The tip is down due to its weight and by the action of a spring. By touching the bottom of the borehole due to the probe body weight, the tip is then pressed against the inductive sensor, thereby activating the alert borehole end (Figure 4c).

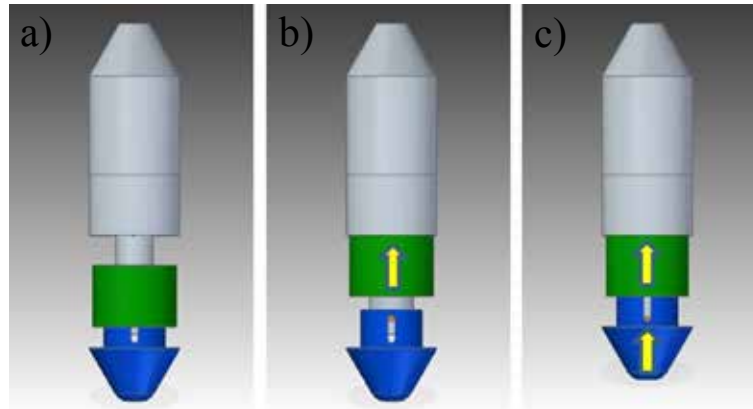

Figure 4 – Equipment description; a) Both sensors are deactivated, b) Water level detection system is activated, c) Bottom borehole detection is also activated

The probe is dropped into the borehole via an umbilical special cable used to suspend the probe into the hole and for measuring the depth related to the surface. The depth is given by reading an rotary encoder, sensitive to the handling of the umbilical cable in a portable reel. The support of this encoder is stuck in the borehole entrance and the cable is connected to portable reel for easy use in the field (Figure 5). The LCD display is attached to the reel (not showed on Figure 5).



Figure 5 – Portable reel and probe.

The water detection system has an LCD display that shows the measurements. This display shows three measurements: special cable length to suspend the probe, (ALT R), borehole depth, (ALT P) and water height (ALT A); all measurements in meters (Figure 6).



Figure 6 – LCD display

The operation to determine borehole depth and water level, by using the equipment, should be as follows: once the probe is placed at the borehole entrance user must clear the LCD display. Then the user drops the probe inside the borehole until it reaches the bottom borehole, and finally, the user checks the depth and water level on the LCD display.

### LABORATORY TESTING

Laboratory tests were conducted to analyze the performance of the probe and the correct functioning of the sensors. The mechanical test consists of introducing the probe and cable into a water tank and observing the mechanical behavior of the dispositive. Figure 7 shows the probe: before being immersed in water when the depth of the hole is already being measured (Figure 7a), once submerged with the buoy floating in water and the water column beginning to be measured (Figure 7b), and, finally, the tip is up by touching the bottom of the water tank and all final measured values are shown on the display (Figure 7c). When the bottom borehole detection sensor is activated, the system stops measuring and a message that the measurement was completed appears on the display the words “DISTANC ATINGIDA”.

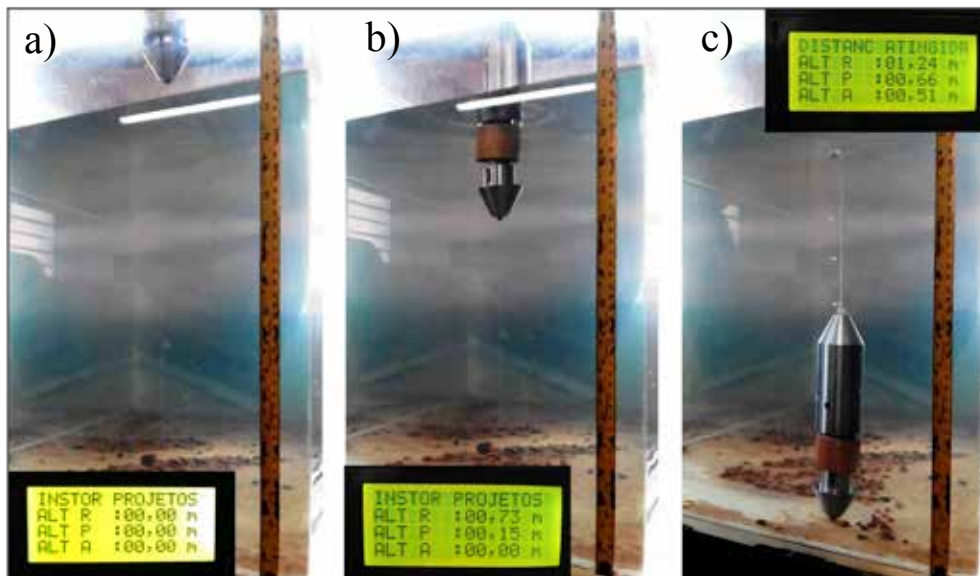

Figure 7 –a) Both sensors are deactivated, b) Water level detection system is activated, c) Bottom borehole detection is also activated

### CONCLUSIONS

In seeking to improve the performance of blasting, a device that quickly provide information on the presence or not of water, as well as the depth and the level of the water column before the explosives loading, is usually necessary and desirable. Using the real water level and depth data, the

blaster can easily decide the best loading technique or explosive for each borehole, maximizing the use of ANFO, the lowest blasting agent available to achieve more efficient, safe, and cost-saving blasts.

The tests conducted in the laboratory showed the adequate functioning of the probe and sensor's timing. These results indicate that the equipment developed in this study has great potential to help improve explosive performance, then the loading operation will be based on more accurate information.

#### REFERENCES

- Dick, R. A., Andrea, D. V. D., & Fletcher, L. R. (2001). Back to basics: Blasthole loading. *The Journal of Explosives Engineering*, volume 11(4). Retrieved from International Society of Explosives Engineers website: <https://www.isee.org/>
- Hopler, R. B. (1998). *ISEE Blaster's handbook* (17th ed.). Ohio, USA.
- López Jimeno, C., López Jimeno, E., & García Bermúdez, P. (2003). Manual de perforación y voladura de rocas [Rock drilling and blasting handbook]. Madrid, España.
- Munaretti, E. (2002). *Desenvolvimento e avaliação de desempenho de misturas explosivas a base de nitrato de amônio e óleo combustível [Development and evaluation of explosive mixtures of performance the basis of ammonium nitrate and fuel oil]* (Doctoral dissertation). UFRGS. (Retrieved from <http://hdl.handle.net/10183/19037>)
- Pilshaw, S.R. (1988). *Dewatering the blast area: A means of achieving productivity*. Retrieved from International Society of Explosives Engineers website: <https://www.isee.org/>



# ENERGY AUTOMATION AND HYBRIDIZATION: INTEGRATING RENEWABLE ENERGY FOR OFF-GRID MINING

John Okoro  
*Mining and Metals Desk*  
*VERGNET GROUP*  
*12, Rue des Chataigniers, 45140,*  
*Ormes, France.*  
*j.okoro@vergnet.fr*



**24th World Mining Congress**  
MINING IN A WORLD OF INNOVATION  
October 18-21, 2016 • Rio de Janeiro /RJ • Brazil

## ENERGY AUTOMATION AND HYBRIDIZATION: INTEGRATING RENEWABLE ENERGY FOR OFF-GRID MINING

### ABSTRACT

The Mining industry is constantly under the siege of fluctuating prices of metals and minerals. In order to stay competitive therefore, Mines must adopt a proactive approach to optimizing operating costs in order to deliver value to shareholders on a consistent basis and justify the capital investments. Energy is one major elements which constitutes huge operating costs for miners, especially for mines located off-grid, and in areas of erratic power supply and weak power infrastructure. In off grid locations, mines must supply 100 percent of their power requirements without the grid. This means they have to rely heavily on diesel or fossil-fired generators for electricity. In all the above mentioned conditions, integrating wind and/or solar farms with baseload Thermal plants (i.e to form a hybrid setup) can help to economically meet the power needs of mines while reducing the fuel consumed and carbon emissions. While integrating renewables to existing grid can offer significant economic benefits, each project will require the right technology and system design to address the grid characteristics on-site constraints and requirements. At the center of these challenges, grid stability must drive the design of hybrid systems (i.e Wind/solar and gensets) to ensure their successful operation over time. In order to achieve this, as well as the necessary hybrid efficiency required to meet mining power demands, proper hybrid controls are required to provide the necessary system balance and reliability. The objective of the paper is to illustrate the functioning of a hybrid power plant for mining operations and how hybrid controls help to deliver reliable power in hybrid set ups. In this paper, the author will particularly make references to practical case studies and examples.

### KEYWORDS

Renewable Power, Wind, Solar, Hybrid Power Plant, Off-Grid Mine,

## INTRODUCTION TO RENEWABLES FOR MINING

The increase in the adoption of renewables for mining operations is encouraged by several factors, which fall largely into the categories below:

- **The economics:** The location of certain mines, and their off-grid characteristics, makes it necessary to hedge against the high cost of electricity production by substitution with full or partial renewable energy electricity production. For thermal plants, the supply risks and attendant fluctuations of fuel prices could surge energy security and hence put mines at great operational risks. Therefore, integrating renewable energy into mining grids sometimes makes economic sense, and this has been one of the major factors that has spurred the growth of the renewable for mining industry.
- **Environmental awareness:** The propagation of sustainability best practices and the increasing demands and pressures around global warming has also largely influenced the growth of the renewables for mining industry. Today, competitive mining is almost synonymous with environmentally compliant mining, and miners are forced to comply with the most stringent policies and regulations regarding sustainability. One of the major sources of carbon emission for miners, is their means of electricity production. For mines located in areas with good renewable energy potential, exploiting this potential for electricity generation could help meet sustainability targets at a corporate, regional, or local level. Today, most of the leading mining corporation have either implemented a renewable for mining project or are in advanced stages to implement one.
- **Learning curve in the renewables for mining industry:** The advancement of renewable energy technologies (notable wind and solar) coupled with steady improvements in storage technologies has increased the confidence of miners in renewable energy as a generation option. Furthermore, the implementation of innovative financing models for previously executed renewables for mining projects have also been a positive factor in the growth of the industry. A decade ago, this would not have been possible. Today, there are references across the world to benchmark with for every new renewable for mining project. This learning curve has greatly derisked the industry and with every new project implemented, there is less pessimism.

These factors, amongst others, have led to the growth of the renewables for mining industry with several projects already implemented around the world. According to Navigant research (2013) the renewable for mining industry will reach 3.9 billion dollars in annual market value by 2022, from \$210.5 million in 2013. This represents a growth from less than 0.1 percent to about 5 percent. Wind and Solar power is expected to account for more than 70 percent of the total investments by 2022.

In spite of the benefits, the renewables for mining industry still faces significant challenges that has stymied the seamless growth of the industry. Integrating renewable energy for mining operations would require a proper understanding of certain factors that are key to ensuring the success of these projects. These factors fall into three broad categories: regulatory, financial, and technical.

- **Regulatory factors:** This refers to the policy and government related factors that affect the energy decisions of heavy consumers, which mining belongs. The absence of good policy frameworks and allocation could put at great risk initiatives to self-generate or buy electricity from renewable energy set-up.
- **Financial factors:** This refers to the economic viability of these projects. Renewable for Mining projects face significant challenges related to financing and adaptive business models. Usually, mines have shorter duration forecasts than the usual 20-25 years of life of these renewable energy assets. Major projects work would therefore require a marriage between the life of the mine and the life of the assets otherwise the payback expected for these assets could be greatly threatened. For mining companies, bearing Capital Expenditure Costs (hereafter referred to as CAPEX) for energy infrastructure is not an approach that is admired. For a project to work therefore, there must be an agreement between the mine (the off taker)

and the technology provider. Proposing innovative business (and financial) models is going to determine if this opportunity is realized on a large scale.

- Technical factors speak about the technical viability of re4mining projects. Combining renewable with mining operations requires first and foremost a proper understanding of mining power patterns and demands as well as base load requirements. Renewable supply intermittent power and these fluctuations are not condonable in mining operations, due to the risk associated with any power failure. Renewable energy solutions (or hybrid plants) must therefore meet the technical constraints and requirements of the mining process.

Without a proper understanding of these challenges, and pragmatic approaches to addressing them, renewable energy integration, though beneficial for mining, would remain largely unpopular, and realizing the potential of renewable energy for mining would at best remain a work in progress. This paper focuses on the technical aspect of renewable for Mining projects: notably on showing how issues around intermittency, plant availability and power security can be guaranteed while integrating renewable in mining operations, in a hybrid power set-up.

### **INTEGRATING RENEWABLES FOR MINING OPERATIONS, UNDERSTANDING THE TECHNICAL SIDE: “KINI” BIG DEAL?**

Integrating renewables for Mining requires, first and foremost, a proper understanding of energy consumption for mining operations. Mining is an energy intensive process, and energy is an important component of mining operations. When evaluating electricity needs for mining operations, the following pertinent concepts must be taken into consideration:

- **Base load requirements:** Mining operations have base load power demands that must constantly be met. For this purpose therefore, power plants that supply mining operations must consistently generate and supply the electrical power needed to satisfy the base load or minimum demand. Failure to meet this requirement, could result in serious financial losses and damages to mining equipment.
- **Uninterrupted power availability:** Mines do not go on holidays. The competitiveness of mines depends largely on their uninterrupted operation throughout the course of the year, for several years. Power plants that supply mining operations must be designed to meet this minimum requirement of availability throughout the mine’s life. These plants must be designed therefore with allowances to allow for maintenance, repairs, and other conditions that may arise without jeopardizing the overall power supply to the mine. Mine’s power plants are therefore built with additional back up generation capacity to make up for any of these foreseen or unforeseen circumstances.
- **Electrical Compliance:** For mining operations, power plant must be designed to comply with necessary electrical requirements, such as MV Voltage, frequency, power factor, voltage drops during starting, etc. Mining operations have very thin appetite for errors, as the consequences are colossal should any unplanned incidences arise due to lack of compliance to necessary onsite electrical demands and best practices.

#### **Power Supply in Conventional Mining in Off-Grid Locations**

In conventional mining, for mines located off-grid, thermal plants are used to meet the base load requirements and often total electricity requirements of the mine. In this conditions, mines are totally exposed to fuel supply risks associated with the usage and dependence of fuel. The reliability of the entire power system is therefore dependent upon the cost of fuel, the rate of consumption of the fuel, and the attendant logistics challenges associated with the utilization of fuels driven generation. In these conditions also, the risks associated with carbon di-oxide emission cannot be over emphasized. Most thermal power plants used in mining operations usually require comparatively smaller upfront capital requirement but are associated with higher operating and maintenance costs.

#### **Integrating Renewables**

Integrating renewables into mining operations, for an off-grid mine, could take one of several forms:

- **100% Renewables:** In this condition, renewables is designed and implemented to totally meet the base load and power requirements of the mining operations. This requires a combination with storage technology as well as an uninterrupted smart grid control system to regulate and monitor the system availability. Although there is no doubt about the technical feasibility of this system, there is however no mine today that runs on 100% renewables. The attendant prohibitive costs and infancy of this technology is one that makes it unattractive.
- **Renewables + Thermal Plant (Hybrid Power Plant):** Hybrid power combinations are today the most common when considering integration of renewable energy for mining operations. This involves the integration of renewable energy technologies (the most common being wind or solar PV) into existing or new Thermal Plants (i.e. Baseload plants). Hybrid Power plants could also be implemented at the beginning of an off-grid mine, in which case the system is designed from the on-set to operate using one or more renewable energy technologies with one or more thermal power sources. Hybrid power systems require special design considerations. They must be designed to supply the quality and reliability of Mine's power needs while ensuring that the reliance on fuel based generation is minimized so as to reduce operating expenses. The next section provides more insights about Hybrid power plants and their functioning.

### Hybrid Power Plants for Mining Operations

A Hybrid power plant refers to a power system in which renewable energy, at a non-guaranteed power delivery source, is integrated into an electrical network with existing thermal plant, with guaranteed power delivery (generally HFO/LFO Thermal or Gas Thermal plants). Therefore in a hybrid power system, there are two important sources of generation:

- **Thermal Power Plants/Generators:** Thermal generators act as the primary source of electricity and help to regulate the network by controlling the voltage and frequency (within a range of tolerance). It is the control system of the generators that plays this important role by controlling the active and reactive power.
- **Renewable Energy Plants (i.e Solar and Wind):** Renewable Energy farms produce electricity in a fluctuating manner based on the availability of the renewable resource (i.e Wind, Solar, etc). The production of energy is largely dependent on resource availability, based on site specific factors. Due to this limitation, wind and solar farms cannot produce electricity in a constant manner (without combination with some base load friendly support system). However, because of the lower levelized cost of electricity (LCOE) obtainable from renewable sources, renewable energy plants must be given priority in a Hybrid plant in order to reduce the overall cost of electricity, than would have been obtainable by running fully on thermal generators.

Integrating renewable energy farms with thermal plants comes with attendant challenges, which aggravates with increasing penetration of renewables in a hybrid set-up. If the penetration of renewable energy is greater than 30 percent of the minimum load of the mine, a system for control and regulation of the hybrid plant is necessary in order to avoid technical challenges. Below 30 percent penetration, a control system will not be necessary because any variations in supply from the renewable energy plant does not put the stability of the entire system into danger.

However, if high penetration is the objective, a control system is indispensable. This control system will regulate the interaction between the renewable energy generation facility and the thermal generation facility the power supplied from the various sources of generation (according to criteria planned into the design) and ensure that the overall generation output from the hybrid power plant is stable irrespective of the variations of the power produced from the solar or wind farm.

### Hybrid Power Controllers

Hybrid Power controllers are at the heart of Hybrid Power plants. They help to provide the necessary regulatory function that is necessary for the Hybrid Power Plant to function efficiently. At the heart of a Hybrid Controller is communication. Integrated in their functioning are real time feedbacks and controllers that help to monitor the power balance, energy quality and grid stability, always in the safest manner for people, longest life of equipment and maximum fuel savings. The real

time monitoring then allows the hybrid controller to send back feedbacks and necessary commands to perform some actions.

Although the functioning of a hybrid software follows a generic approach, various controllers have their peculiarities and proprietary specifications. Their architecture and functionalities differ from one another. Due to this constraint, this paper would explain the functioning of Hybrid Controllers by making reference to the Hybrid Wizard™, a hybrid controller developed by Vergnet.

### **Hybrid Wizard™ Controller**

Hybrid Wizard™ solution was born from on-site feedbacks from heavy energy consumers and hybrid power plants to better control the grid and the produced power by considering not only the power balance but energy quality and grid stability. Hybrid Wizard™ architecture and functionalities are patents owned by Vergnet.

The Hybrid Wizard™ is a complete control-command system that automatically adjusts the wind farm, solar plants and the diesel generators active and reactive production set points according to the real-time grid conditions (such as network resilience, voltage plan, power quality status, ...) in a continuous and auto-adaptive manner.

Hybrid Wizard™ controller has several functional units:

- The “eyes”: Dedicated measuring devices are placed on the network to define the loads working conditions (through electrical indicators such as voltage on several points of the network, frequency, harmonic levels, currents, active and reactive power exchanges, power factor, short-circuit power (grid resilience),...). V-Scada system and Gensets control command are connected on the same communication network and data are exchanged in a continuous manner. This serves to provide an Understanding the grid status.
- The “brain”: Hybrid Wizard™ controller aggregates all the data and calculates optimal working conditions for the solar farm and diesel plants, always keeping in mind the best working conditions for the load. The network is the heart of the system. The controller uses admissible thresholds determined after tuned observation of the network, state-of-the-art values and results of hybrid studies to detect if the best working conditions are achieved. This helps for calculating the grid’s renewable bearing capability.
- The “hands”: Solar farm active and reactive power setpoints, as well as diesel generators capacities even storage or dump loads, if available, are used as a lever to control the global power exchanges and the grid status. This helps for tuning the power balance to achieve the best working conditions and maximum fuel savings

The hardware architecture and software specifications are presented below:

### Hybrid Wizard™ Hardware

Hybrid wizard™ system uses real-time measurement on several points of the grid to calculate the grid renewable bearing capacity. If the bearing capacity is overpassed, the active and reactive power set points are adjusted to come back to admissible behavior. If the bearing capacity is not exceeded, increase of renewable active power injection is permitted. The grid bearing capacity has been previously defined and justified to the client during integration and hybrid studies and is the reference criteria for Hybrid Wizard™ system. Each major generating unit is therefore equipped with measuring devices which are all linked to the SCADA system through copper or wireless.

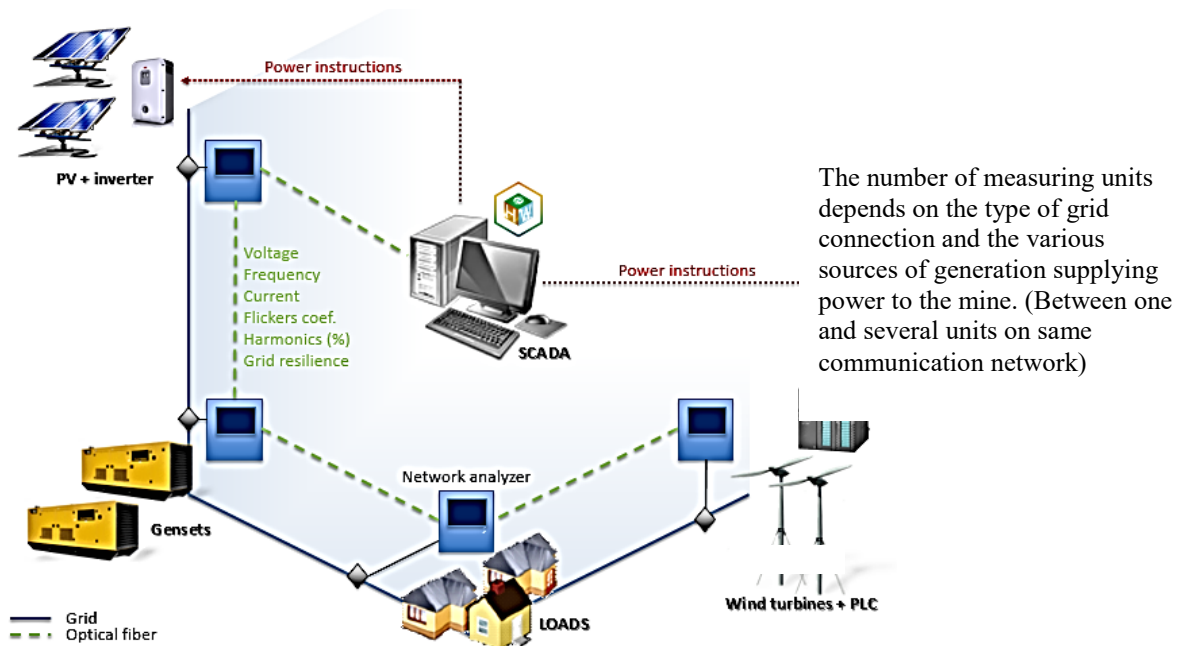

Figure 1 - General overview of a Hybrid power set-up showing communication between various generation points.

### Hybrid Wizard™ Software

The aim of the software is to produce as much renewable power as possible in safe conditions for high quality performances and maximum fuel savings. In order to achieve this goal the control system focuses on the following points:

- Active and reactive renewable power regulation: Maximize the renewable power to generate fuel savings. This can only be done in acceptable thermal plant working conditions such as:
  - Diesel generators working on optimal power setpoints (on a long-term basis) – they should not work in inefficient low-load conditions.
  - Power exchanges between load and generation is done in certified safety and quality conditions.
  - Service continuity and stability are ensured by considering in a permanent (load flow, primary reserve) and transient (voltage and frequency short-term deviations) basis all types of contingencies such as Motor starting, wind gusts, load shedding...
- Register and control energy production and power quality key data in order to generate complete production reports – thus leading to proper understanding of the grid.
- Access to maintenance tools such as alarms & events...
- Real-time surveillance of the wind farm plant, the solar and thermal generators status – all summarized on one same SCADA system.

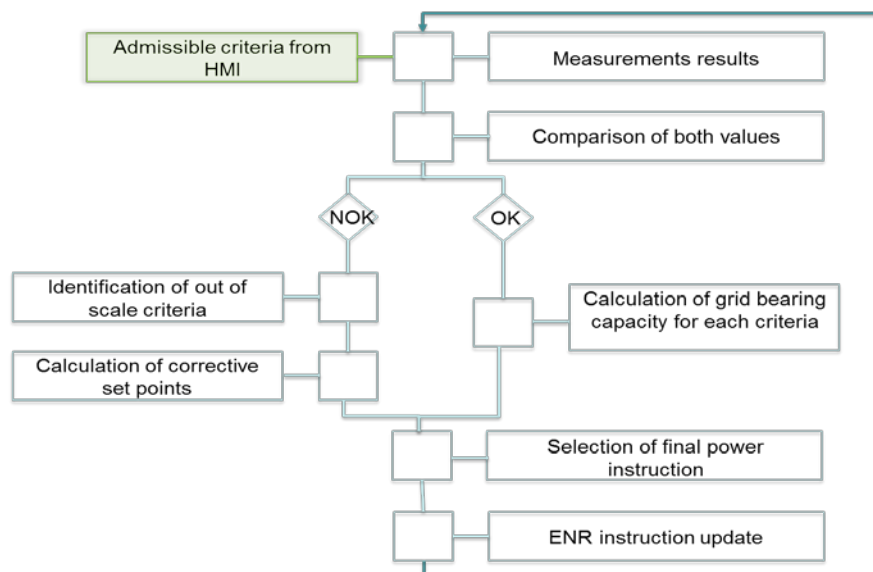

Figure 2 - Communication loop for a hybrid power set-up.

For each key electrical criterion considered in the studies (like voltage, frequency, thermal current, etc.) a regulation loop compares the measured value with the threshold admissible value. If one of the criteria is not compliant, corrective setpoints are determined: expected working conditions are therefore always ensured. If all the criteria are fulfilled, increasing of renewable production is permitted.

## CASE STUDY: HYBRID POWER INTEGRATION FOR SNIM IRON ORE MINE IN MAURITANIA

### Context and Overview

Since 2000, electricity demand in Mauritania has been growing more than 10% per year on average, driven primarily by increasing demand from Mining operations, and other industrial activities.

Although SOMELEC, the National utility company, is presently implementing several initiatives and projects, this is unable to measure up to the demand, hence putting a responsibility on several mines to operate their own mini grids and power plants.

The SNIM Company (Société Nationale Industrielle et Minières) operates iron ore mines in Zouerate, region of Tiris in Mauritania. SNIM is the 2<sup>nd</sup> largest producer of iron-ore in Africa employing about 10,000 people.

### Site Conditions

In order to reduce carbon footprint and energy production costs, SNIM issued an EPC tender in 2010 for the construction and integration of a 5MW Wind farm with the existing Thermal generation plant.

The Zouerate region of Mauritania where the SNIM mine operates has a peculiar arid weather and geographical conditions. The region has a peculiar temperate condition which could make construction activities very difficult to manage, considering the hard and dusty climate, as well as accessibility challenges to the project site.

The existing grid was powered by a 16 MW diesel plant equipped with 4 diesel gensets, feeding a 5.5 kV grid. Consumers are essentially motors for ore conveyors and crushers (with more than 20 loads ranging from 200KW-600KW) while others consist of low voltage loads. Vergnet proposed a full study to assess and guarantee the achievable wind power penetration



according to wind profile, grid load cycles and diesel gensets characteristics. The major aim was to ensure the injection of renewable power while preserving Safety and security of goods and persons, Availability of the grid and Power quality.

The main goal of the study was to define the maximum penetration rate so that grid parameters, mainly voltage and frequency shifts, remain compliant with standards and client needs during normal and unforeseen transient events. Essentially, the wind farm must not disturb the diesel power plant in both transient and steady states.

The final project consisted of 16 Wind turbines (Model GEV MP-C), all necessary connections and electrical installations, and the Hybrid Wizard™. The Wind farm was connected to the existing Thermal Plant with the necessary integration. The figure below shows the single line diagram of the final set up.

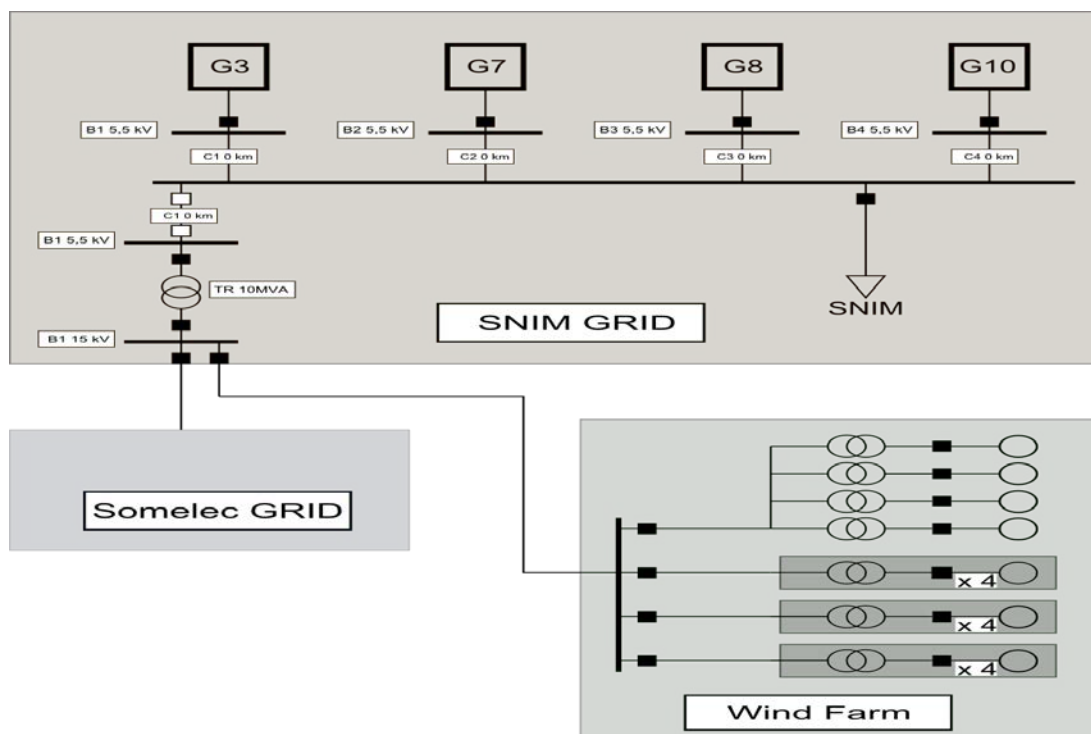

Figure 3 – Single line diagram showing the electrical connection for the hybrid Power plant at the SNIM Mine.

### Control Functions highlights

The slow regulation loops (typically based on 10-min measures) are controlled through SCADA systems. SCADA systems are installed on the Wind farm and the Thermal Plant as well as the Hybrid Wizard having its own SCADA system. The transient functions requesting a quick control answer (such as sudden load shedding leading to transient frequency deviations) are monitored and controlled by dedicated PLC units which are the corrective levers in the system. This architecture ensures the best service continuity and the quickest answer for the frequency and voltage regulation systems.

The Hybrid SCADA system can be used to have feedback on economic criteria (i.e. renewable energy utilization, and availability) and technical criteria (Wind penetration ratio,

Instantaneous active and reactive power from Wind Farm and Storage System, Electrical Criteria status (voltage, frequency, harmonics, etc)

This hybrid controller ensures a permanent feedback loop to maximize the use of renewable energy without compromise on the power quality (i.e. voltage deviation, Grid stability, Flicker, Harmonics, Service continuity, etc.) and the safe integration of renewable energy

Example 1: Voltage Plan

The voltage plan must be kept within the range  $U_{min} / U_{max}$ . The Hybrid Wizard™ controls the voltage and the power factor (Tan [Φ]) via the active and / or the reactive power exchanged with SNIM’s electrical grid.

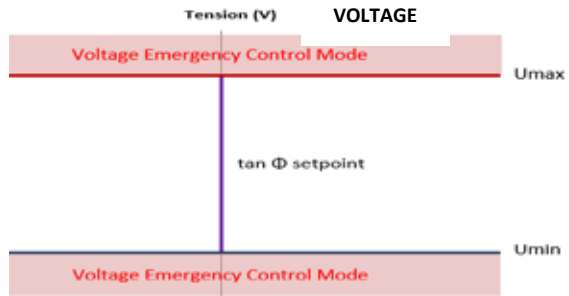

Figure 4 – Voltage regulation approach

Example 2: Frequency

To adjust the frequency of the grid, the power plant takes into account the balance between production and consumption in real time. The grid frequency is the indicator of the right balance.

A high frequency will indicate that production is more important than consumption on the grid and vice versa.

The frequency regulation is described in the diagram opposite:

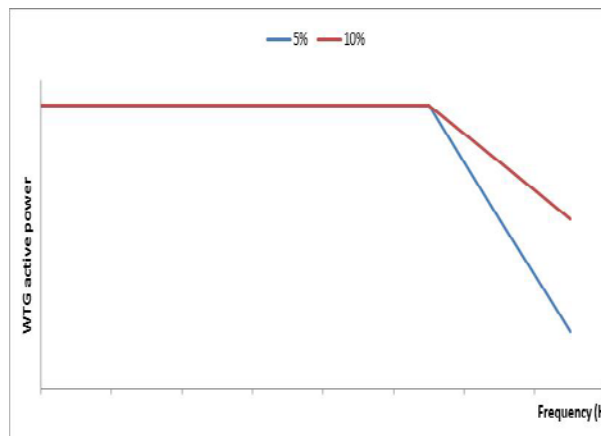

Figure 5 – Frequency regulation approach

Hybrid Wizard™ will then determine the final set point taking into account all the results obtained for each monitored parameter.



Figure 6 – Input-Output data acquisition and results handling for the Hybrid Wizard controls

A second regulation loop will then compare the steady-state results to the maximum admissible renewable setpoints determined thanks to hybrid studies and measurements on-site (loading conditions, number of gensets).

Project Overview and Figures:

- Wind farm output: 19 GW h/year
- Fuel savings: 4800 t/year
- Pollution avoided (CO<sub>2</sub>, NO<sub>x</sub>, SO<sub>2</sub>): 11 500 t/year

## CONCLUSION

There is increasing adoption of renewable energy technologies in mining operations via a hybrid set up. From our projects with the mining sector, there are lessons learned that must be considered when integrating renewable energy into mine's grid, especially for off-grid mines. Some of these key criteria and considerations are highlighted below:

- Grid stability must be the primary criteria for the system design and should drive the system requirement. Factors like consumption, load capacity, grid parameters, etc. must be considered.

Grid measurements, and evaluation of Possibility of performing grid measurements, identify weak points, etc.

- Technology choice and design must be the result of thorough feasibility studies, not an a priori choice. Renewable resource assessment must be carried out.
- The system design and sizing of the PV or Wind farm must be made to meet with the mine's load requirements and rightly sized with existing thermal plant(s). Ensure that choice of technology fits the local situation. Reasonable targets for penetration should be used.
- Possibility to improve the system and targets (taking into consideration that technology is evolving fast). Possible evolutions of the load consumption should be considered from the very beginning.
- Life of mine consideration must be integrated into planning and profitability estimations.
- Local content must be built into construction and operations. If know how is not already present, a capability building programme must be included.

## REFERENCES

Navigant Research (2013). *Renewable Energy in the Mining Industry*. February 17, 2014

## BIBLIOGRAPHY

The following references are not cited in this paper, but provide additional information.

Arnoldus, M. (2015). *Introduction to mining for renewable energy industry*. Paper presented at Renewables and mining summit and exhibition (workshop). Johannesburg, July 2015.

Carbon war room (2014). *Sunshine for mines: implementing renewable energy for off-grid operations*. March 2014.

Chadbourne, "Opportunities: Renewable Energy Projects near Mines -- Chile, Brazil, Canada, Africa, Deal Structures", [http://www.chadbourne.com/Renewable\\_Energy\\_Near\\_Mines\\_projectfinance/](http://www.chadbourne.com/Renewable_Energy_Near_Mines_projectfinance/), Retrieved February 2014.

Hillig, T. (2014). *Solar- Diesel-Hybrid power plants at mines: opportunities for external investors*. December 2014.

Rivard and Moustapha (2015). *Mining as a pioneer of renewable energy integration*. Paper presented at Renewables and mining summit and exhibition. Johannesburg, July 2015.

# IGBT BASED HIGH POWER DRIVES FOR SALIENT-POLE SYNCHRONOUS MACHINES

\* Gilberto da Cunha, Paulo José Torri and Joable Andrade Alves

*WEG DRIVES AND CONTROLS*

*3000, Prefeito Waldemar Grubba Street*

*Jaraguá do Sul, SC, Brazil*

*(\*Corresponding author: [gilbertoc@weg.net](mailto:gilbertoc@weg.net))*



**24th World Mining Congress**

MINING IN A WORLD OF INNOVATION

October 18-21, 2016 • Rio de Janeiro /RJ • Brazil

## IGBT BASED HIGH POWER DRIVES FOR SALIENT-POLE SYNCHRONOUS MACHINES

### ABSTRACT

High-power grinding mills are used in the cement and mining industries to crush clinker or copper ore and grind these materials to fine powder. Synchronous motors with a high number of pole pairs are used as the prime movers. They are traditionally fed by load-commutated thyristorized cycloconverters. These are prone to failure modes that can lead to excessive torque pulsations and high overcurrents. A novel and reliable direct drive uses a voltage source inverter that operates at the unity power factor for increased efficiency. This paper presents the results of an implemented control strategy applied to an IGBT based Medium Voltage inverter with NPC topology driving a salient-pole synchronous AC machine. The control system provides a high dynamic performance with a fast torque control. The additional functionalities necessary to drive a synchronous AC machine are depicted. The results also show the behavior of a synchronous bypass transfer of the machine from the inverter to the line supply.

### KEYWORDS

Converter control, dynamic model, medium voltage drive, multi-level inverter, synchronous machine

### INTRODUCTION

The production of cement requires machinery for crushing the cement clinker produced by a rotary kiln and to subsequently grind it to powder. The same procedure is followed in copper mining (Rodriguez et al., 2005). Crushed copper ore is ground to powder, from which the copper content is extracted in a chemical process.

The production of fine powder is efficiently done in grinding (SAG) mills. Figure 1 shows the construction of a SAG mill (J. Holtz, Cunha, Petry, & Torri, 2015).

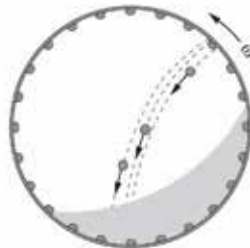

Figure 1 – Cross section of a SAG mill.

The failures that have occurred during the operation of SAG mills were caused by a cycloconverter for its control. This unreliable cycloconverter can be replaced by a pulse width modulated (PWM) voltage source inverter for energy conversion and control (G. da Cunha, Brum Candido, Silva Dias, Sari, & Torri, 2013).

### MEDIUM-VOLTAGE THREE-LEVEL INVERTER

The basic structure of a medium-voltage (MV) drive consists of an active or passive input rectifier, a decoupling DC link, an IGBT, SCR or thyristor based voltage source inverter (VSI) and optional line and/or motor filters, Figure 2. The Neutral Point Clamped (NPC) multilevel topology is shown in Figure 3. (J. D. I. Holtz, 1975; Nabae, Takahashi, & Akagi, 1981). This inverter topology can be used in MV drives to reach a certain voltage level without series connection of switching devices. Thus, the efficiency levels can reach 99%. The switching frequency should be as low as possible due to the power losses and it is usually

limited to a few hundred hertz. Normally, special modulation techniques are needed to produce the minimum harmonic distortion in the motor current in all range of speed and torque (Oikonomou, 2008). In some applications the floating neutral point requires control of voltage deviation (G. da Cunha & Torri, 2007).

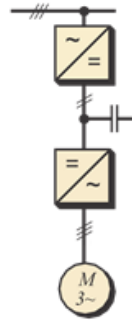

Figure 2 – Basic structure of a medium-voltage ac drive.

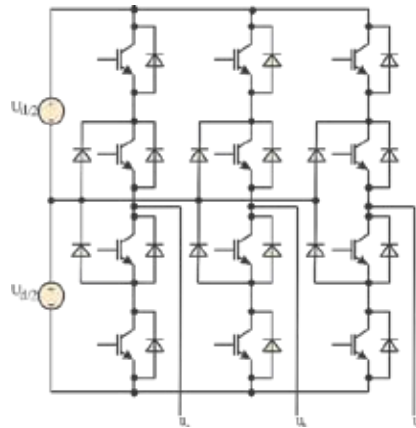

Figure 3 – Three-level Neutral Point Clamped (NPC) multilevel topology.

### SYNCHRONOUS MACHINES MODEL

For SAG mill drives operating at a very low mechanical speed, synchronous machines are a better choice. The absence of slip reduces machine losses and leads to a better tradeoff between the installation cost and efficiency (J. Holtz et al., 2015). A large airgap increases the reliability.

The shows the machine model normally used for the control design. Moreover, the differential equations are:

$$u_f = R_f i_f + \frac{d\psi_f}{dt} \quad (1)$$

$$u_d = R_s i_d + \frac{d\psi_d}{dt} - \omega \psi_q \quad (2)$$

$$u_q = R_s i_q + \frac{d\psi_q}{dt} + \omega \psi_d$$

$$u_D = R_D i_D + \frac{d\psi_D}{dt} = 0 \quad (3)$$

$$u_Q = R_Q i_Q + \frac{d\psi_Q}{dt} = 0$$

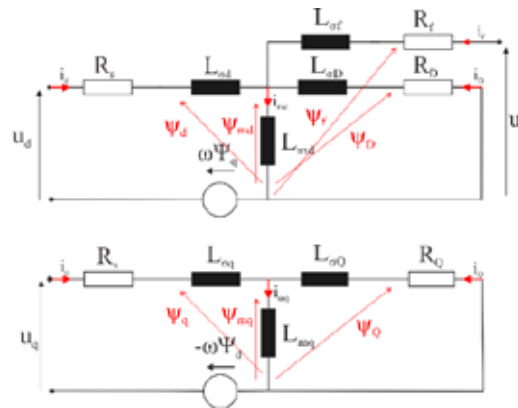

Figure 4 - Synchronous AC machines model in d-q reference frame.

Where  $u_d$  and  $u_q$  are the components of the armature (stator) voltage,  $u_f$  and  $i_f$  are the field winding's excitation voltage and respective current,  $i_d$  and  $i_q$  are the components of the stator current, and  $i_D$  and  $i_Q$  are the components of the damper winding current in the rotor. The respective winding resistances  $R_i$  are marked by subscripts.  $L_d$  and  $L_q$  are the inductances of the armature winding, and  $L_f$  is the inductance of the field winding. Mutual inductances are marked by subscripts, e.g.,  $L_{mq}$  describes the magnetic coupling in the q-axis armature winding. Also the leakage windings inductance  $L_{\sigma i}$  and linkage fluxes  $\psi_i$  are marked by subscripts. The linkage fluxes equations are:

$$\begin{bmatrix} \psi_d \\ \psi_q \\ \psi_f \\ \psi_D \\ \psi_Q \end{bmatrix} = \begin{bmatrix} L_d & 0 & L_{md} & L_{md} & 0 \\ 0 & L_q & 0 & 0 & L_{mq} \\ L_{md} & 0 & L_f & L_{md} & 0 \\ L_{md} & 0 & L_{md} & L_D & 0 \\ 0 & L_{mq} & 0 & 0 & L_Q \end{bmatrix} \begin{bmatrix} i_d \\ i_q \\ i_f \\ i_D \\ i_Q \end{bmatrix} \quad (4)$$

### SYNCHRONOUS MOTOR DRIVE CONTROL

The control is embedded in the drive, as shown in Figure 5. The current controller receives the fundamental stator current vector from an estimator (J. Holtz & Oikonomou, 2008). In addition, the stator flux linkage vector is estimated. Its argument  $\delta$  is used for field-oriented control, whereas its magnitude acts through a field-weakening controller and a flux controller on the excitation of the synchronous motor (Gilberto da Cunha, 2015). Superimposed is a controller for speed. The control imposes also that the motor operates at unity power factor.

High-dynamic closed-loop control is enabled by extracting the fundamental component of the stator flux linkage vector from its distorted trajectory. The process is based on the reconstruction of the harmonic content of the actual pulse pattern.

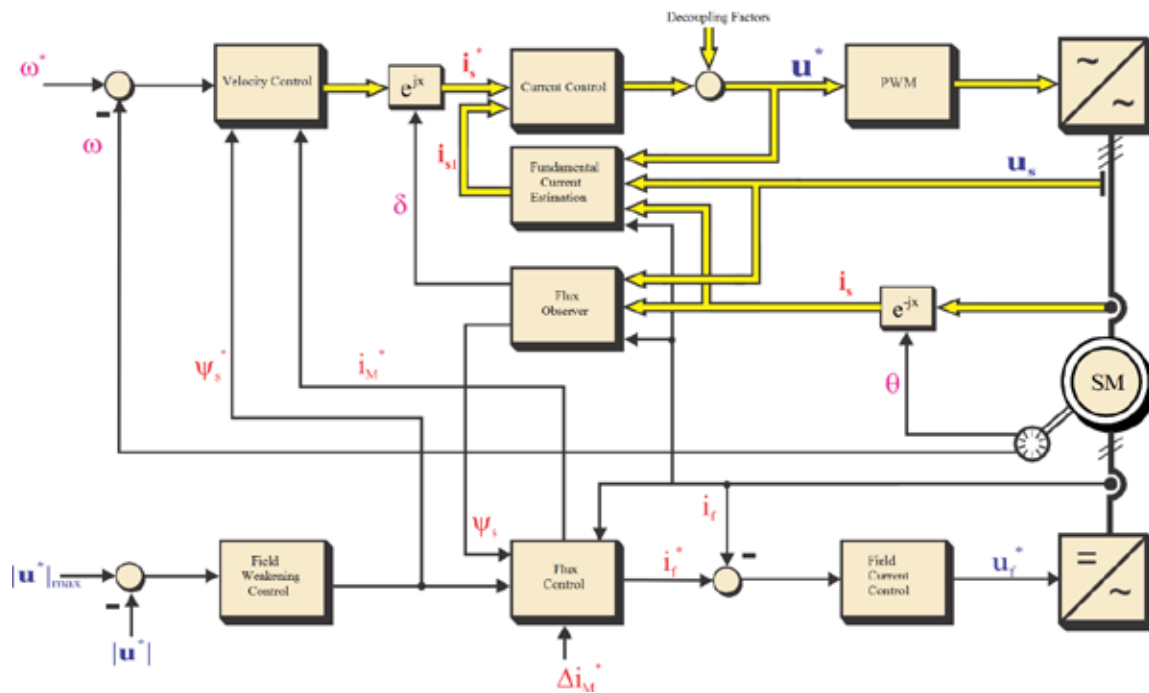

Figure 5 - Signal flow graph of the drive control system.

## RESULTS

This section presents the measurements made in a 1000 HP machine coupled to a dynamometer.

Some applications require the drive to start the motor and transfer it to the line supply without any interruption or system disturbance. After acceleration from standstill, the SAG mill operates at a constant speed. It is then decoupled from the inverter and commutated to the ac mains to increase the efficiency. The commutation is shown in Figure 6.

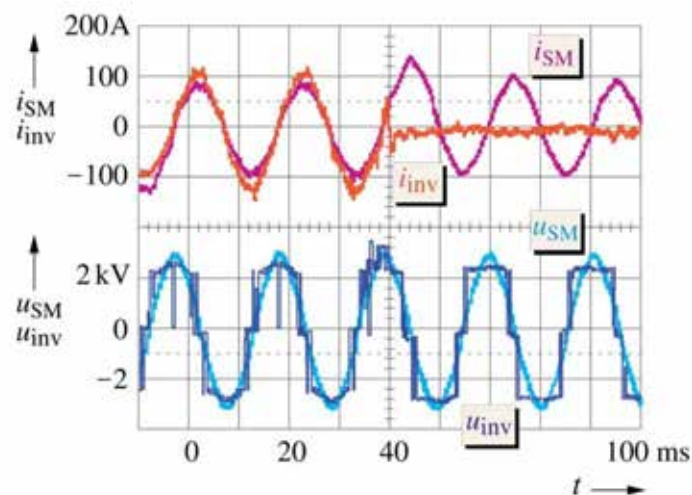

Figure 6 - Commutation at  $t_1=40\text{ms}$  of the stator current from the inverter to the ac mains.



In the Figure 7 shows the measured waveforms of the phase a stator current and inverter output potential at a fundamental frequency of 30.0 Hz operating at unity power factor. In the Figure 7 also shows the synchronous optimal modulation at a switching frequency of 240 Hz.

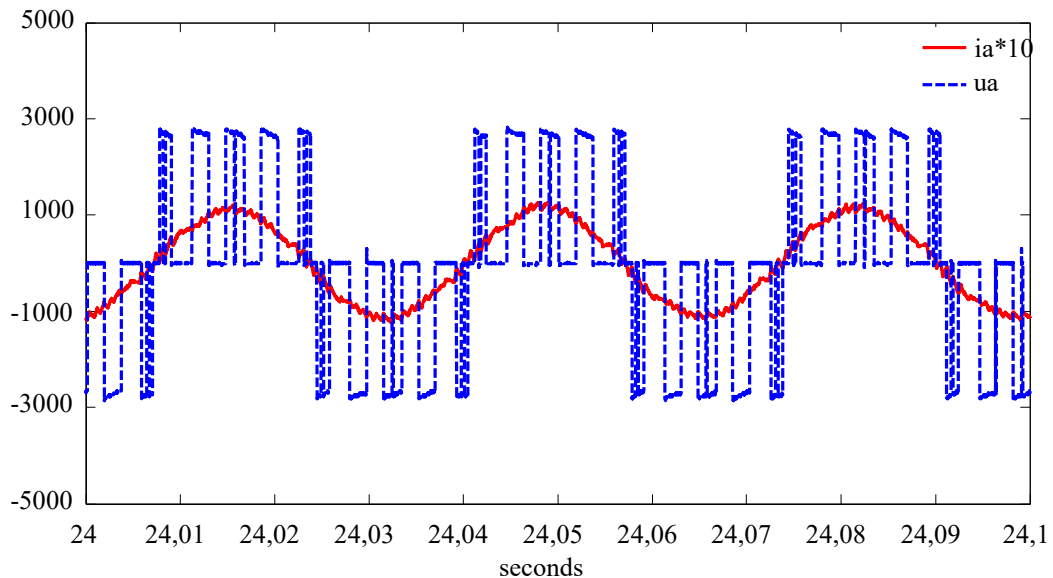

Figure 7 - Measured waveforms of the phase a stator current and inverter output potential.

This drive control system presented here is at a copper mining company in Iran. For example, one of the six plants has two motors 4.7MW (3300V/846A) for ball mill and more two motor 3.75MW (3300V/678.5A) for the sag mill. The total power of this plant of 16.9MW.

### SUMMARY

SAG mills are widely used in the cement and copper mining industries for mineral grinding. Separately excited synchronous machines with a high number of pole pairs are used as drive motors. They operate at a very low rotational speed.

The stator windings are commonly fed by a thyristorized load-commutated cycloconverter. Present drive systems have shown undesired outages owed to frequent malfunctions of the cycloconverters required for extensive repair work.

An IGBT voltage source inverter could be used for energy conversion and control. This permits the unity power factor operation that increases the efficiency of the drive system. Extreme low-frequency switching reduces the dynamic losses of the medium-voltage devices. The machine is modeled by a fifth-order set of state equations. Experimental results are obtained from a downscaled laboratory drive and from a drive system in the field.

### REFERENCES

- Cunha, G. da. (2015). *Controle Vetorial com Saturação de Fluxo de Maquinas Sincronas de Media Tensao com Rotor Bobinado e Escovas*. Universidade Regional de Blumenau, Brasil.
- Cunha, G. da, Brum Candido, D., Silva Dias, A. da, Sari, M., & Torri, P. J. (2013). A NPC IGBT based medium voltage inverter applied to salient pole wound rotor synchronous machine. *Power*

- Electronics Conference (COBEP), 2013 Brazilian* (pp. 852–857). doi:10.1109/COBEP.2013.6785214
- Cunha, G. da, & Torri, P. J. (2007). Neutral Point Potential Balancing Algorithm at High Modulation Index for Three-Level Medium Voltage Inverter. *9th Brazilian Power Electronic Conference*, 523–527.
- Holtz, J., Cunha, G. da, Petry, N., & Torri, P. J. (2015). Control of Large Salient-Pole Synchronous Machines Using Synchronous Optimal Pulsewidth Modulation. *Industrial Electronics, IEEE Transactions on*, 62(6), 3372–3379. doi:10.1109/TIE.2014.2378732
- Holtz, J. D. I. D. I. (1975). Selbstgefuehrter wechselrichter Self-commutated inverter. Google Patents. Retrieved from <http://www.google.com/patents/DE2339034A1?cl=en>
- Holtz, J., & Oikonomou, N. (2008). Estimation of the Fundamental Current in Low-Switching-Frequency High Dynamic Medium-Voltage Drives. *Industry Applications, IEEE Transactions on*, 44(5), 1597–1605. doi:10.1109/TIA.2008.2002212
- Nabae, A., Takahashi, I., & Akagi, H. (1981). A New Neutral-Point-Clamped PWM Inverter. *Industry Applications, IEEE Transactions on*, IA-17(5), 518–523. doi:10.1109/TIA.1981.4503992
- Oikonomou, N. (2008). *Control of Medium-Voltage Drives at Very Low Switching Frequency*. (L. V. Berlin, Ed.). Bergischen Universitat-GH Wuppertal.
- Rodriguez, J. R., Pontt, J., Newman, P., Musalem, R., Miranda, H., Moran, L., & Alzamora, G. (2005). Technical evaluation and practical experience of high-power grinding mill drives in mining applications. *Industry Applications, IEEE Transactions on*, 41(3), 866–874. doi:10.1109/TIA.2005.847321

# IT-OT AS A PRODUCTIVITY ENABLER IN MINING

\*Constantino Seixas Filho

*Accenture*

*Rua Senador Milton Campos 145*

*34.000-000 – Vila da Serra - Nova Lima - Brazil*

*(\*Corresponding author: [constantino.seixas@accenture.com](mailto:constantino.seixas@accenture.com))*



**24th World Mining Congress**

MINING IN A WORLD OF INNOVATION

October 18-21, 2016 • Rio de Janeiro /RJ • Brazil

## IT-OT AS A PRODUCTIVITY ENABLER IN MINING

### ABSTRACT

IT and OT convergence is the main innovation driver in mining today. The digital revolution, propelled by new technologies such as robotics, data analytics, mobility, cloud computing, wireless and Industrial Internet of Things (IIoT), is provoking a disruptive transformation in mining, allowing the total horizontal integration of information from pit to port and vertically from sensor to the board room. Autonomous fleet, autonomous yard and other robotic applications are removing people from hazardous areas, improving mining safety, improving productivity and reducing costs. Companies that properly addressed the complexities of IT-OT integration, orchestrating those two essential areas under the same governance, are the only ones to achieve all the benefits of this revolution. This paper discusses the motivations to promote this transformation, strategies that leading mining companies are employing, and the benefits they are obtaining. It also shows a path to guide companies in this direction, using a big-bang or an evolutionary approach.

### KEYWORDS

IT-OT convergence, digital transformation, Industrial Internet of Things (IIoT), master plan, governance, as a service (aaS), Enterprise Resource Planning (ERP)

### INTRODUCTION

Before examining their convergence, it is important to define the terms IT and OT. IT refers to all the processes and technologies in a company that deal with information. IT manages the people, the company's relationship with customers, the logistics, and of course, the business information related to production, quality, inventory and maintenance. Enterprise Resource Planning (ERP) is the most important system representative of this level. OT deals with the operational processes: the machines or assets that perform the production, and everything that happens inside the mining production chain from pit to port. OT has a strong presence at the site and IT is more distant from day-to-day interventions in the process plant. Figure 1 uses the ISA-95 model to depict IT and OT.

Figure 1 also shows old labels such as automation, corporate IT and industrial IT/manufacturing IT. Of course, IT technologies are pervasive and are part of all activities performed from level four down to level one. This demonstrates that it is impossible to deny the influence of IT.

IT and OT converge in every sense. The technologies adopted in both areas are the same, and the tools necessary to improve activities are quite similar. The same computers, the same networks, the same protocols, and the same data bases are used today in IT and OT domains. Independent on the hierarchical level of functionality, data analytics is a necessary tool to identify issues and opportunities. If someone is dedicated to level 3 activities and wants, for example, to optimise port production, choosing the best throughput route to deliver ore from a car dumper to a ship loader, an optimisation algorithm based on a port operations model will be used. An instrumentation engineer (level 1), trying to detect which instrument is performing abnormally, will use multivariate statistics to find the bad actors. These are all digital technologies made available in recent years.

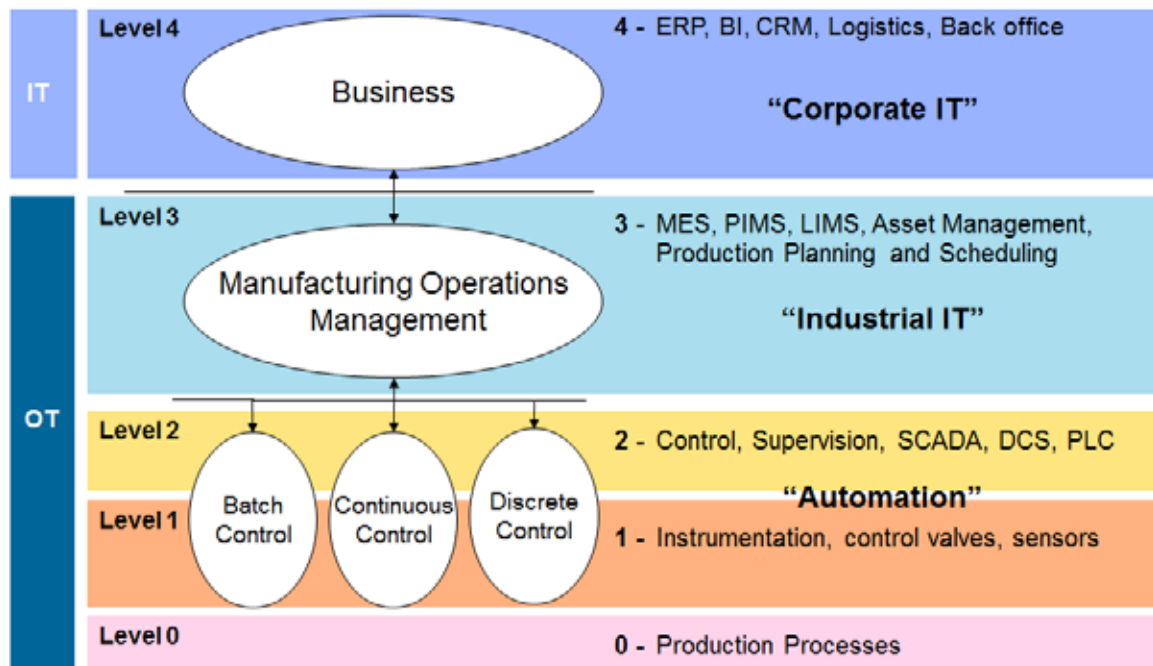

Figure 1 – IT and OT definition using the ISA-95 functional hierarchy

Production systems are highly interconnected in all modern operations architectures. It is possible to visualise all assets in a plant from the enterprise level to a sensor, seven levels below, using the same “asset tree” visualisation object. This interconnection eliminates islands or blind zones in the plant and is a foundation when moving an organisation from a siloed model to a fully transparent one. This is the upside. This full interconnection, however, makes the operational environment more vulnerable to cyberattacks, initiated outside, or from inside, the organisation. Continuous improvements in architectural protections, allied with methodological procedures, are necessary. An isolated project is not able to address this issue. A continuously evolving programme must be executed. This is another characteristic of the new digital enterprise. Almost everything should run as a programme.

In the new digital organisation, innovation has a role that determines if the company perishes or survives. Companies need to reinvent themselves continuously. In one transformation program led by Accenture, the client asked how he could be certain that innovation introduced in the current year would not be obsolete in the next year. The answer was to develop an innovation centre in alliance with the client, with the objective of challenging continuously every used technology, every achieved improvement and every concept considered to be the definitive trend in mining. No idea should be considered absurd or unfeasible. All should be examined exhaustively in a creative, diversified innovation arena. Google, Waze, Facebook and so many other inventive companies were not created by conventional people, or by conventional thinking.

Governance, not technology, is the most important hurdle when promoting IT-OT convergence. How can we merge IT and OT organisations? How can we motivate C-level to sponsor such a deep transformation? How can we facilitate it happening quickly, permanently and with minimum scars? These are the main topics to be discussed in this paper.

### THE GOVERNANCE

The decision to promote IT-OT convergence comes from C-level; in most cases from the CEO. He will designate an owner for this transformation; in general the CIO, or the COO.

Once defined who leads, an external consultancy company will help to define the transformation. This kind of process should never be insourced, because it is very difficult to transform an organisation without external references and guidance. The cultural, historical and affective links with the old organisation can be very strong, and resistant to disruption without external help.

Another scenario exists when the client decides to adopt an evolutionary transformation. In general, this occurs when there is no CEO sponsorship or understanding of the importance of the IT-OT transformation, and when the CIO and the automation manager (or equivalent) decide to run smoothly in the modernisation direction, without any disruptive action. They decide to work more closely together as a survival reaction. This path is, of course, much slower and will not achieve the same degree of transformation as the big-bang strategy. It happens mainly because of the fear of moving under a single governance, due to cultural factors and the belief that “the culture of the other area does not fit my business” and that “my area will lose power if I agree to merging the two domains”.

So, how do OT and IT differ on a maturity point of view in facing the challenges of the “new digital enterprise”?

### THE MATURITY GAP

The question of how OT and IT differ regarding maturity in facing these challenges requires the examination of other more fundamental queries. How should a modern mining company be shaped in order to be competitive in a digital world? What is happening in mining? What are the main trends?

The “from-to” diagram in Table 1 helps to address these questions.

Table 1 – Digital Mining Evolution

<b>Dimension</b>	<b>Current State</b>	<b>Future State</b>
<b>Safety</b>	Uncertain people location	People and equipment traceable in real time
	Local operations	Remote and autonomous operations
	Slopes and dams inspected periodically	Continuous monitoring
<b>Control rooms and operations</b>	Controlled on site	Centralised in a ROC
<b>Ore characterisation</b>	In the lab	In the pit
<b>Planning x Actuals</b>	Big gap	Fully correlated
<b>Mine simulation</b>	Engineering phase	Engineering and operations phase. Digital Twin.
<b>Visualisation</b>	2D	3D
<b>Maintenance</b>	Mainly corrective	Mainly condition-based and predictive
<b>Documentation</b>	Non-standardised, decentralised	Standardised, centralised and available on mobile devices

<b>Mine-concentration plant synchronisation</b>	Siloed	Concentration calibrated dynamically to match arriving ore
<b>Production accounting</b>	Unreliable, big gaps, no root causes analysis	Real time inventory
<b>Process/Production</b>	High variability	Low variability
<b>Measurements</b>	Not reliable, high % of manual inputs, unsupervised	Fully automatic, reliable, supervised in real time
<b>Production Planning</b>	Local: mine, concentration, rail, ports	Global production chain optimisation
<b>Instrumentation</b>	Point-to-Point, 4-20mA	Smart sensors
<b>UG Mine</b>	High human footprint	Reduce human footprint
<b>Yard Management</b>	Manual/remote, unprecise positioning, 2D yard map	Autonomous, HP positioning, 3D stockpiling, RT inventory
<b>Robotics</b>	Robotics as an exception	Common use of robotics
<b>Energy and Water</b>	Energy and water managed loosely	Energy and water management are core activities
<b>On-line sensors</b>	Limited utilisation	Intensive use of on-line sensors for moisture, size distribution, grade, etc.

Returning to the question of maturity regarding the accomplishment of the mining transformation agenda, Automation/OT organisational maturity is in general, behind IT, and this lag should be addressed when merging the two domains.

### AUTOMATION TRANSFORMATION

The automation transformation is a necessary step in the IT-OT convergence process. It analyses the real state of automation to understand the diversity of assets, the connectivity issues, the lack of standardisation, the obsolescence risk, the lack of written procedures for architecture, support activities, safety, risk analysis, configuration management, back-up procedures, documentation management, knowledge management and so many other topics.

All this As-Is analysis is addressed by the “Automation Master Plan”. The Master Plan will bring awareness on the maturity state of automation in three dimensions: assets and technologies; procedures; and people capabilities. Upon conclusion of the As-Is assessment, a gap analysis is done to measure what is lacking in automation to fulfil the business role, aligned with the transformation agenda. Finally, the To-Be report will define the automation transformation steps necessary to move the old OT to the new OT organisation.

Table 2 shows typical deliverables of a Master Plan development.

Table 2 – Automation Master Plan typical deliverables

<b>Activity</b>	<b>Description</b>
<b>As-Is and To-Be Technical Architecture</b>	Used to map current and future connectivity, identify automation islands and check ISA-99 cybersecurity compliance
<b>Asset Map</b>	Maps all automation assets from levels 1 to 3 according to ISA-95. Each colour in the map represents a different asset supplier. The more colours in the map, the higher the TCO (Total Cost of Ownership). It is also used for obsolescence analysis
<b>Multidimensional Maturity Matrix</b>	Analyses the maturity of several dimensions compared to leading world practices. The matrix compares the maturity of several different plants and measures the gap to the desired next level to be achieved, chosen by the company
<b>Unitary Process Template</b>	Maps each unitary process and decides the recommended minimum and desired instrumentation, control, supervision and asset monitoring functions to provide asset management, productivity management using KPIs, production accounting and other higher-level functionalities
<b>Opportunities map – project prioritisation</b>	Lists all recommended projects necessary to move the organisation from the As-Is to the To-Be condition
<b>Recommended Project List</b>	Prioritises projects according to their benefits, cost of implementation, technologies maturity, and other strategic objectives such as improving safety (people and environment), improving relationships with communities, etc.
<b>Project description and high level summary</b>	Describes the projects selected for implementation in wave 1
<b>Project Charters</b>	Builds the business case for the most relevant projects
<b>Multidimensional Roadmap</b>	Depicts selected projects in implementation in waves 1, 2 and 3 classified in several dimensions: infrastructure, automation, governance, sustainability, etc.
<b>Detailed timeline</b>	Depicts a detailed plan for project implementation
<b>Capabilities Map against a Competency Model</b>	Measures workers' skills when compared to an international capabilities model

The normal Automation Master Plan scope of work discussed so far is independent of any IT-OT convergence considerations. In an IT-OT convergence transformation, more activities should be included, and of course, governance is the focus and the most important topic. Figure 2 shows the main activities of an Automation Transformation Plan.



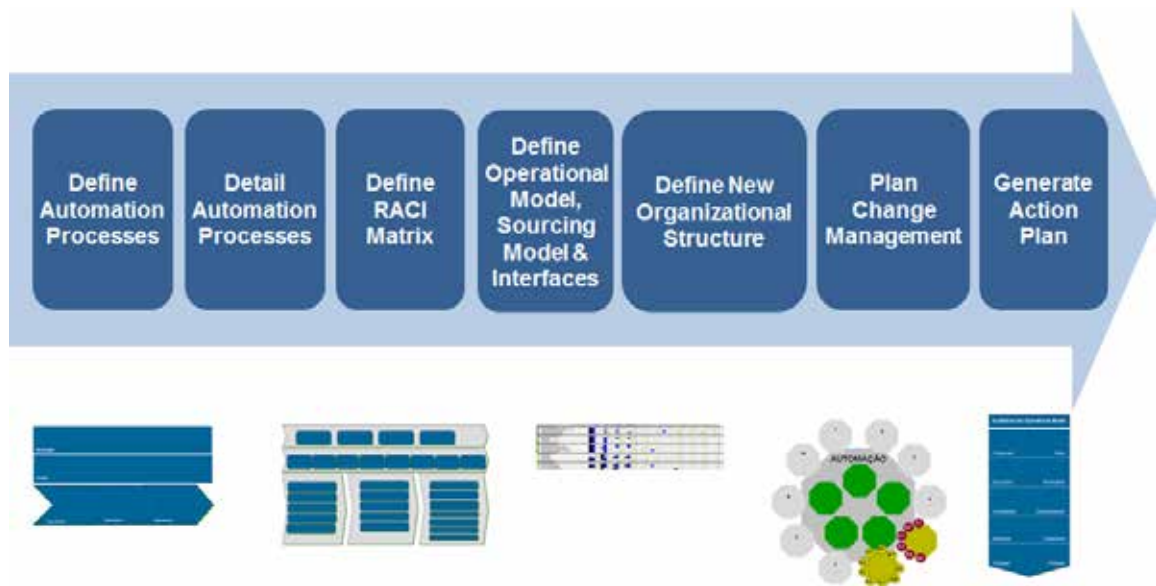

Figure 2 – IT-OT Convergence – Automation Transformation Plan

The first step is to map all automation processes in order to understand automation scope coverage. For each process, it is necessary to define how it will be performed in the future, which tools and applications it will use and the crew necessary to perform it. To have good coverage of all those details, it is recommended to break down process activities in at least three depth levels.

Once the scope of automation processes is known, the Automation Transformation Plan defines an operating model. It discusses how centralised the organisation wants to be, which processes will be managed by the central organisation structure and which processes will be kept local to the sites. Another very important analysis is which processes and activities will be insourced and which ones will be executed externally as a service. Today, there is a significant trend to do as much as possible as a service, in order to reduce costs and change the organisation from a more operational one to a more productivity-oriented one. People on the plant will then manage the achievement of productivity KPIs instead of executing each individual task.

The interface between the new IT-OT and the other areas of the organisation is also relevant. Suppose that the Automation Transformation Plan decides on the standardisation of suppliers, but the procurement area is not aligned to this decision and decides to acquire automation assets, prioritising price. This will invalidate all the efforts of reducing colours in the asset map to improve TCO. IT-OT convergence is about orchestration, and eliminating apprehension of the IT-OT interface is key.

In the IT-OT transformation, people matter the most. The Automation Master Plan developed the first level of people capabilities analysis. Now, the IT-OT convergence plan will focus on people gaps in two ways. First, there may be missing processes; for example, cybersecurity. Perhaps there will be no cybersecurity specialist in the automation team. Now that IT and OT architectures are merged and full vertical integration from ERP to sensor is provided, the systems are more vulnerable to cyberattacks that can reach a SCADA, a PLC, a DCS or other automation system. The consequences of having a control kidnapped can be devastating. This capabilities study will certainly look to address this gap.

Another gap is in people formation in general. To support this digital transformation, old instrumentation specialists, operations and maintenance people need to be redeployed. The technologies brought to monitor equipment and model the process will be brand new to several specialists. Specific training will be necessary on new standards such as: ISA-18.02 – alarm management; ISA-100, wireless systems for automation; ISA-101 HMIs; ISA-95 – Enterprise Control Systems Integration; ISA-88 batch processes; OPC DA, OPC HDA, OPC UA industrial

communication protocols; and IEC 61131-3 programming languages, etc. Training on fieldbuses (HART, FF, Profibus-PA), fuzzy logic, neural networks, genetic algorithms, statistical multivariate monitoring, similarity-based models and other advanced topics – now part of academic graduate engineering courses – will need to be included in the new company formation curriculum.

Promoting modernisation transformations without focusing on change management tends to yield scant or no results. A pertinent example is the difficulty of introducing smart instrumentation in mining. Smart instruments are already the standard in chemical industries, oil and gas, and even in new ethanol and sugar industries, but they are considered difficult to maintain in the mining industry. The problem is not the technology, which is already readily available, but the lack of preparation for mining personnel, and their resistance to adopt new technologies. This reaction is delaying the achievement of the benefits brought by smart instrumentation in the mining industry. The consequence is unreliable measurements and expensive instrument maintenance.

### GOING “aaS – AS A SERVICE”

#### Which Activities Should Mining Companies Execute as a Service?

Companies have been doing ERP supporting as a service for a long time, as well as data centres management, replaced recently by cloud, and back office outsourcing. Managing licensing in a big organisation, just for office activities, involves version control, new versions deployment, managing the acquisition of large licenses volumes, negotiating special packages to bring commercial advantages, and so on. This is not IT core business, but consumes time and effort that could be better used elsewhere.

IT knows that implementing these activities as a service and managing SLA achievement is a good approach. Now, IT and OT are focusing on defining several operational activities as a service. The most common ones are the MES, LIMS and Historian support. The third party company provides several services: platform support; help desk; new functionalities implementation under an evolution programme or on demand; managing the achievement of business cases, and executing all *ad hoc* activities necessary to keep systems alive and users supported and trained. The sustainability of these programmes is a key success factor for the adoption of these technologies. For example, forgetting to update MES to fit new KPIs, reports, or functionalities will mean Excel-based patches sprouting from one day to another. Establishing governance in large MES programmes is also a challenge. The new features demanded by users from the diverse sites and the variety of product categories can provoke the creation of MES dialects that compromise the unity of the platform and increase the cost of code maintenance. The MES programme steering committee, working with the third party company, will keep the programme on track.

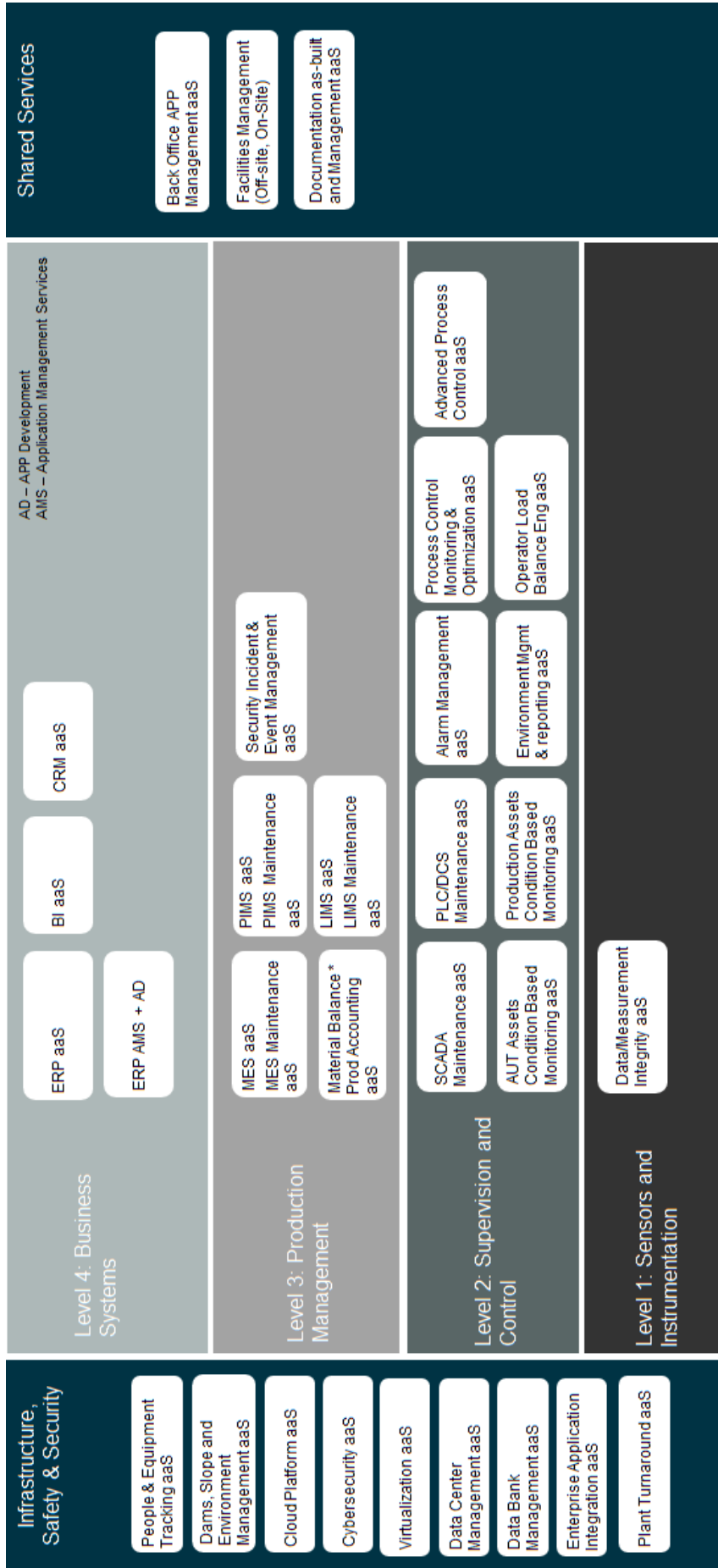

Figure 3– Outsourcing Activities Map of IT-OT Operations

Several industry segments much more conservative and critical than mining have adopted the “as-a-service model”. In oil refineries, documentation centralisation, as-built and management are provided as a service. More recently, regulatory and advanced process control, including the development of new MPC – Model Predictive Control algorithms, have been outsourced. The same occurs with mass balance and data reconciliation.

The main operational activities supplied successfully as a service are: alarm management; process control optimisation; production accounting and data reconciliation; advanced process control; data integrity (it verifies if field measurements are consistent); condition based monitoring of both automation and production assets; and, even SCADA, DCS and PLS support services. Figure 3 shows the most common activities currently provided as a service.

In cases where a Remote Operating Centre (ROC) is in place, several ROC activities can be supplied as a service. People and equipment tracking is provided as a service in mining and oil industries.

The condition-based monitoring can be executed on premises, from an asset control centre inside the company, or remotely from a control centre in the services supplier office (Figure 4). It is normal to have a combination of activities executed remotely and others locally in the company site. When executing regulatory control optimisation, for example, a local team will optimise the control loops at the site and a second remote team will continue managing the KPIs of the stabilised loops to maintain all that have been improved previously. The centralised remote office produces all the reports to summarise the technical results and translate them into economic indicators to be presented to top management.



Figure 3 – Example of a remote process control centre

Going “as a service” will improve mining efficiency to unprecedented levels, because this model proved to be more economical and effective in other industries before arriving in mining. Leading mining companies are now employing aggressive “as-a-service programmes” and will exceed competition.

## INNOVATION

Mining is looking for breakthrough innovation more than any other industry. This is because mining is suffering several threats, including volatile market prices, high energy costs, low mineral grades, high extraction costs, water scarcity, and low operating efficiency. Becoming cost efficient, energy efficient, and production-asset efficient is now mandatory, as is being environmentally and socially aware.

Companies cannot postpone any longer. Examining energy prices illustrates this. In the last ten years, several electro intensive metallurgical companies closed production in LATAM. They moved to places where there are low-cost energy sources, such as in the Middle East. There, electricity, produced from natural gas, is very cheap and can be used, for example, in aluminium electrolysis.

Mining needs to look for creativity and efficiency. A manufacturing company with an OEE of 50% no longer exists – they closed their doors a long time ago. Mining needs to follow the other industries' quest for efficiency.

The answer could be to produce part of their energy using wind farms, solar panels, geothermic energy, or, in special geographies, small hydroelectric plants. In parallel, miners need to use energy-efficient processes and to manage energy utilisation. How many over-specified and non-efficient motors can be found in a mining company? Are the plants exploring the use of frequency inverters? Are the mines running motor-pumps in their Best Efficiency Point (BEP)? Are the furnaces burning fuel efficiently, at the stoichiometric air-fuel ratio? Are the burners control loops tuned and operating in automatic mode? We know that most of the plants are not doing that. They are not managing energy utilisation in a centralised EMS (Energy Management System), they are not monitoring control loops continuously, and they do not manage energy demand properly. The innovation here is not the creation of new products or technologies. The digital applications are already available. The innovation is in the mindset change, in the use of modern methodologies and in changing from a project-based philosophy to a programme-based one.

What about employing some innovative ideas? Using image processing to measure ore size distribution in the belt conveyor is new and useful, as is using radar technology to measure stockpiles geometry in real time, and operating the bucket wheel reclaimer in autonomous mode. It increases throughput and allows smooth autonomous operation with low rate variability. Using a blimp to transport cargo to or from a mine in Africa, if there are no suitable roads, is also a novel and potentially successful strategy. Characterising ore in the pit, tracking that ore to the crushers and informing the concentration plant of the ore quality feeding the plant for the next ten hours would also have a high impact. These strategies would mean revolutionary gains to an industry that is used to accepting imprecision or lack of information as a given.

How will mining companies become more innovative? This could be achieved by embracing digital, choosing technological partners to help organise their thinking and defining a roadmap for innovation. Another possibility is creating or being part of an ecosystem of technological partners that will look for a solution for mining problems. This involves the company, universities, international research centres and technology suppliers interested in investing, based on the principle that they will have the miner's loyalty. Bringing creative startups, aligned with digital technological solutions, is another recommended action. Adopting trends like platform thinking, digital ecosystem and interoperability will bring the revolution from other leading industries to mining.

## IT-OT CONVERGENCE RESULTS

### What Competitive Advantages are Early Adopters of the IT-OT Convergence Paradigm Achieving?

Accenture is working for the leading mining companies and some of them are already very advanced in their IT-OT convergence agenda. They completed the governance part very quickly using a top-down approach and began the transformation journey. In parallel to aligning the new organisation, documenting processes, defining an integrated architecture, and using the platform concept to outline the several operational layers according to ISA-95, they are implementing ambitious production management programmes. This includes migrating from a "do all internally" to a "preserve the knowledge and do the most of operational activities as a service" approach.

The main perceptions of the early adopters today are:

- Those companies can implement new projects and programmes faster, with less bureaucracy and more cheaply than a conventional organisation.
- The projects are short-cycled and more successful, because business case realisation is a premise in all new initiatives, and this activity is generally associated with change management.
- Those companies generalised the adoption of good methodologies like ITIL (Information Technology Infrastructure Library) from IT to automation, formally defining several processes non-existent previously. Gaps like risk management and configuration management have been fulfilled.
- Those companies have more time to focus on innovation. Operations, routines and “inter-department friction” consumed most of those companies’ energy previously.
- They eliminated “information silos” and became more transparent and more quantitative (KPI based), as well. The information for decision making is more reliable, because it suffers less manual intervention.
- They are embracing digital in all its dimensions: tracking people for safety; centralising operations in remote operating centres; implementing autonomous operations; exploring mobility; empowering field services; standardising assets and procedures; simplifying applications used in operations; and, exploring sensors to monitor assets in real time and reduce downtime. We can say that most of this extra productivity comes from digital.
- Old ideas of providing real time ore characterisation, tracking, and accounting, became high priority and are in leading companies’ agenda. It is not a dream any more.
- They are implementing production planning and scheduling in the full production chain instead of isolated mine, beneficiation, rail and port optimisation.
- They are operating with less people, and more efficiently because of the integration of information.
- They shortened time to new technologies, because the right governance and the new architecture facilitates innovation adoption.

## CONCLUSION

It is not correct to say that the leading mining companies have already reached 100% of their IT-OT convergence agendas and are harvesting all the possible benefits. All of them are in the middle of a long journey. Some achieved ROC, and are now looking for centralised production management systems, or vice versa. The great differential, in our opinion, resides in answering the following questions: Who solved the IT-OT governance hurdle and is now free to proceed at high speed in their agenda? On the other hand, who is lost and consuming their resources in this endless governance maze? The answers will make all the difference at a time when investments are scarce. Companies that have already addressed IT-OT governance have done the best for their money and can now proceed efficiently. Such efficiency can determine, ultimately, who wins or loses.

## REFERENCES

1. ANSI/ISA-95.00.01-2000 Enterprise-Control System Integration, Part 1: Models and Terminology
2. ANSI/ISA-95.00.02-2000 Enterprise-Control System Integration, Part 2: Object Model Attributes

# LEAN SPEED OPTIMIZATION APPLIED TO A CYCLIC HAUL OPERATION

\*D. Rylander<sup>1,2</sup>, J. Fryk<sup>2</sup>, P. Wallin<sup>1,3</sup> and J. Axelsson<sup>1</sup>

*<sup>1</sup>School of Innovation, Design and Engineering  
Mälardalen University  
Västerås, Sweden*

*(\*Corresponding author: david.rylander@mdh.se)*

*<sup>2</sup>Volvo Group Trucks Technology  
Göteborg, Sweden*

*<sup>3</sup>Volvo Construction Equipment AB  
Eskilstuna, Sweden*



**24th World Mining Congress**

MINING IN A WORLD OF INNOVATION

October 18-21, 2016 • Rio de Janeiro /RJ • Brazil

## LEAN SPEED OPTIMIZATION APPLIED TO A CYCLIC HAUL OPERATION

### ABSTRACT

Cyclic haul operations are iterative transport operations, often performed by several haulers in a production work step. Cyclic haul operations are common in mining and quarry operations where the purpose of the haul work step is to move mass a relatively short distance e.g., from blasted rock supplies to the mass crushing and separation facility. The operation can include one or several haulers that perform the work simultaneously. When several haulers are used, they are generally not synchronized in an optimized way and operative variations and changes continuously affects the operation. An example of such variations can be that the driving speed and time required for certain maneuvers varies depending on driver skills and machine capacity. An operative change can be that the loading position is moved, leading to changed routes and varying distances. The operative characteristics of the haul work step indicates that there rarely exists a static state that the operators can learn to do efficiently. Our previous research has shown that haul operations can have a fuel reduction potential of up to 40%, depending on the operation characteristics and wastes such as unnecessary stops and waiting. This paper presents and assesses a system solution in a decentralized control system that calculates and advices operators with a speed for just in time arrival to a destination. The purpose of the system is to reduce fuel consumption with an obtained production rate. The system assessment shows that while production rate is obtained, fuel is reduced by up to 20% compared to base line operation in a simple quarry haul work step, including three haulers.

### KEYWORDS

Haulage optimization, Cooperative ITS, Lean Transportation, Intelligent Transport Systems, Speed Assist, Decentralized Control

### INTRODUCTION

In Quarry and Mining operations it is common to have hauling operations that are iterative and cyclic. Cyclic haul operations within the sites has a purpose to move mass short distances from the point of excavation to the mass storage, crushing, screening or facilities. Cyclic haul operations have shown to include operative wastes of up to 30%, which corresponds to an overconsumption of fuel by approximately 30%. The operation can include one or several haulers to perform the work as shown in Figure 1. The operation includes changes and variations such as location of loading and unloading, route characteristics and topology, machine characteristics and different driver skills. The operation capacity is rater discrete due to the limited amount of haulers available leading to a varying amount of operational wastes. The hypothesis of this paper is that waste in terms of waiting time at the destination can be reduced by driving slower aiming at arriving Just in Time (JIT). This reduction in waste can be used on lowering the fuel consumption since a lower driving speed results in less energy consumed. The system consequently use less energy but obtain the same production rate, as long as it is only waste that is removed and not actual production time. To be able to calculate an optimized speed based on JIT arrival in each given situation a set of research questions can be derived:

- How can the future be predicted defining a slot of when the destination is available for the planned activity (load/unload) or to pass a road bottleneck. When will the vehicle ahead in the queue leave the



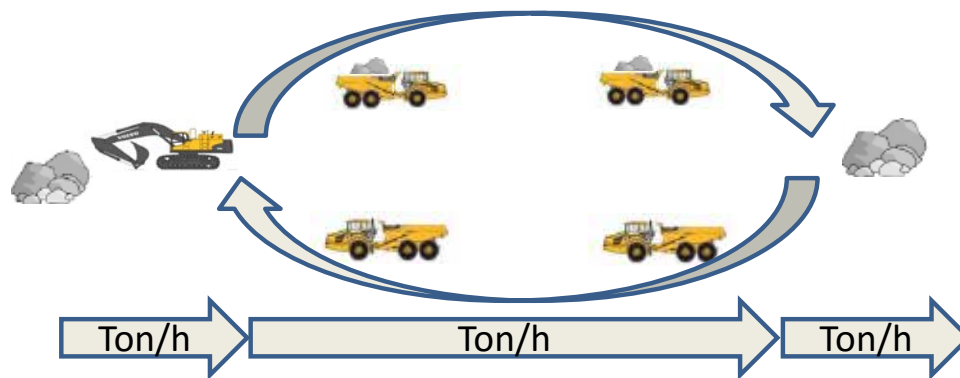

Figure 1 - Balancing cyclic haul work step

slot at the destination and define a (JIT) arrival or simply when is the destination available for the intended activity?

- What activities do the hauler have before it arrives at the destination JIT, of which activities can the time required be estimated?
- What risk do the hauler have of arriving too late and how is risk included in the calculations?
- How can the time left to arrival JIT be used, i.e. how to distribute it over the path to the destination for calculation of an optimized driving speed?
- How can the calculated optimized speed be used to advice or control the vehicle operator (physical or artificial)?

For a system to manage the above tasks it is required to detect, predict and control a large amount of parameters in the flow and manage short lead times from detection to control to be effective.

The need for fast detection and control loops requires sensing and communication capacity at all times and locations during operation. Further the work step, load, haul and unload need to continuously adapt towards the input and output capacity to balance the throughput. From a system and site perspective there are few operational needs to connect to a system outside the operation area. Instead sensor, interfaces and operation data is both produced and consumed locally in the pit. A cyclic haul operation in a quarry or mining environment often consist of a deep pit surrounded by hard rock material in a remote area. Thus, infrastructure based communication cannot be assumed in all locations and situations in the pit. The characteristics and requirements indicate that, in order to be effective, a site-local solution for wireless communication is desired, in combination with a self-learning system that is configurable and adaptive for changes and variations in the operation.

This paper introduces a system solution for JIT arrival in a cyclic haul operation by reducing the driving speed for each individual machine to match throughput of the work step using a decentralized process control system approach. The system of interest is located in each machine and is functional without fixed infrastructure such as access points or base stations. The application logic in each machine is self-learning and self-contained including configuration of the parameters within. The scheduling is individually performed in each hauler based on common operation situation awareness though the continuous communication performed in-between the hauler systems.

By using a decentralized system approach as presented in this paper there are many disadvantages compared to central approaches. Central control has a simpler way of scheduling since it is performed simultaneously and continuously in one place. It is easier to perform fault diagnostics and monitor the operation as well as change and configure scheduling criteria. Unfortunately central control requires a connectivity infrastructure that covers the whole area of the operation. If there are radio shadows resulting in lack in connectivity in e.g., a load area, the loader can never communicate with either the haulers or central systems resulting in a malfunctioned system. If complete connectivity coverage cannot be guaranteed the control and optimization system is not expected to work properly. The benefits with a decentralized approach for the system solution presented in this paper include the system cost that would be required by a centralized network and its components as well as the performance gained by the reliability of coverage in the use of a dedicated short range communication system in-between the haulers. The objective with the system is to decrease speed towards JIT arrival minimizing the waiting time at the destination while minimizing the risk of production loss. By reducing speed and avoiding coming too late which would decrease production rate we expect to lower the fuel consumption without negative effects on the production.

The main contribution with this paper is the assessment of a decentralized system approach for JIT arrival scheduling to destinations for cyclic haul operations in sites and the operational gains in terms of productivity and fuel reductions using real world operation test environments.

The remainder of this paper is structured as follows. In the next section the related work is presented. It is followed by a section describing the method used for the study. Then the analysis of the data collected is presented. The analysis is followed by a section concluding and discussing the results from the study followed by the presentation of future work. Finally the references are listed.

## RELATED WORK

As concluded, earlier research has shown that cyclic quarry operation work steps such as load and haul often are characteristic by operative wastes. These wastes are mainly waiting times caused by unbalanced capacities and continuous operative changes. Rylander & Axelsson (2013) quantify the waste to up to 30% of the machine and vehicle time of operation. As concluded by Rylander, Wallin & Axelsson (2014), reduced speed in a typical hauler can reduce fuel consumption with up to 25% and even 40% if there are additional unnecessary stops during haulage. Related work has introduced the operational requirements and system constraints for efficient operation though the wireless communication available assessments and analysis of system requirements for the optimization to be effective. Optimization of underground haulage using centralized scheduling methods have been presented (Pasternak & Marshall, 2016). What is lacking is a system solution assessment of an implementation in a realistic open pit environment, especially using a decentralized approach.

Decentralized and distributed control and scheduling of traffic is still a rather novel approach and not implemented and used in many applications. Traditional control of airplanes and trains are normally done using a centralized traffic controller even though some aspects and local awareness is done distributed (Prevot, 2002). Presented related work in mining operations indicates centralized traffic control architectures. Decentralized approaches to identified traffic control in haulage optimization challenges have not been found. But decentralized systems have been presented in research for other domains and purposes. Recent developments within the Cooperative ITS (C-ITS) and Vehicular ad-hoc networking (VANET) (Hartenstein & Laberteaux, 2010) area have identified a decentralized system approach based on

a common message set that in Europe is referred to as Cooperative Awareness Message (CAM). This message is continuously broadcasted from the host system at a pre-defined frequency. Depending on connectivity solution, available infrastructure and environment the message set is received by other host systems. The host system can based on the awareness message, advice and inform the driver on suitable actions or take direct control of the machine in e.g., platooning applications (Switkes, Boyd, & Stanek, 2014). Other systems that are of similar type are the AIS system for ships, where the system's main purpose is to avoid collisions but also inform about the traffic conditions in the vicinity (Tetreault, 2005). Currently these types of decentralized systems are not utilized for active scheduling in a production system such as Mining and quarry environments.

As presented, there are no identified functional aspects where the centralized approach would be less superior to decentralized control for the purposes stated. Lead and response times including latencies in communication are currently not foreseen as a major issue since the main lead-times in the control loops are the detection and configuration changes mainly affected by coverage and not so much by other wireless communication performance measures such as bandwidth and latency. For a safety critical system on the other hand, those aspects are relevant to consider. Instead the main gains identified with decentralization in the approach taken are the non-functional aspects of system costs, maintainability, system complexity as well as reliability. In this paper the main contribution is not the theoretical benefit analysis in between the system designs. Instead the contribution is the assessment of a decentralized prototype implementation addressing the main targets of the system:

- Decrease waiting time by reducing speed towards destination JIT
- Ensure that the arrival to a value flow bottleneck is not later than the JIT

## METHOD

To investigate the knowledge gap described above, there is a need to build and assess the feasibility of operations in real world environments. The method used is to collect empirical data on individual hauler operations through analysis of drive cycles with three articulated haulers. The data was collected using two different driving cycles. First a baseline was created where the drivers freely choose their speed during operation, and secondly the optimized operation data was collected, where the drivers were advised to drive in an optimized speed by the optimization system to avoid waiting by JIT arrival.

The drive cycles were performed in a terrain that is comparable to most quarry operations and consist of dry packaged sand and aggregate material. The empirical study contains iteratively performed test cases to achieve aggregated relevant values. To minimize disturbance factors in the test environment the machine was pre-heated before any data was collected and the operators of the machine made several laps to get familiar with the route and process configuration before the test was initiated. The weather conditions during test were 10-15 degrees Celsius, dry but cloudy conditions.

The data was recorded from the machine's internal Controller Area Network (CAN), where fuel consumption data was collected. The time consumed for the different activities were collected using discrete signals from the weight sensors and tipping body angle. Additionally a GPS and the in-vehicle odometer was used to track the machines on the ground surface.

The data collection was performed using three haulers with slightly different characteristics and size to collect data in a realistic quarry operation configuration. They haulers were operated in a work step

including a load area and a unload area with a relatively flat surface path in between at a distance of ~600m. The operation was performed in two iterations during the same work day and conditions. The loading was performed by a wheel loader and the material consisted of mixed aggregated rock material. Each loading was performed in three iterations for each machine to let them have the same amount of mass loaded. The unloading was configured as general stocking performed on a flat surface without maximal storage capacity. The configuration was set up so that the main bottleneck of the operation was the loader.

The test system consists of the optimization system and a measuring system. The optimization system consists of a decentralized scheduling system where each hauler is scheduling its own parameters based on a continually updated operation awareness. The awareness includes the other haulers' operational data and predicted work step timings, which are continuously communicated over a short range communication system utilizing IEEE 802.11p at 5,9GHz.

The basic components of the optimization system installed in each hauler are:

- Mission manager: The mission manager identifies the destinations and purpose (unload, load) applicable and currently active for the host machine.
- Operation Manager: The operation manager keeps track of the activities within the mission and each activity's predicted execution time finish.
- Vehicle CAN network reader: The component reads CAN signals needed for the test configuration. The signals used are Speed, Fuel, Weight and Tipping body angle.
- Communication manager: The communication manager uses vehicular ad hoc networking to continuously communicate estimated time of arrival (ETA) and time to leave (TTL) for the list of destinations and its activities in the host mission. The communication manager receives the ETA and TTL from all other machines in the process and updates the local process database for the activity timing and process scheduling.
- Positioning unit: The positioning system identifies the current geographical GPS-position of the host machine and map match it to the route chosen.
- Map and route manager: Holds and updates the map of the area and identifies the shortest route to the destination based on the current position. The route manager also includes the capacity and limitations to operate a route segment for the host machine.
- Business logic application: The business logic consists of the logic to calculate JIT to a destination based on the location and predictions of all other machines in the process as well as the overall throughput of the operation. The business logic then uses the route and its limitations to distribute the time left for arrival on the route segments to be able to determine an optimized speed at the current position for JIT arrival.
- HMI display unit: The display unit communicates the optimized current speed advice to the operator of the hauler.

The measuring unit is connected to the system of interest so that timings, activities and sensor activity are logged as well as the actual speed, recommended speed and the fuel consumption. The sensors and fuel consumption are logged from the in-vehicle CAN network at 100 Hz.

## ANALYSIS

During the first test cycles without the system the operators of the haulers could drive freely creating an operational base line. During the second test cycles the same operation was performed with the

same machines and drivers with the system enabled. The operators were instructed to follow the speed advice presented for them. To analyze the outcome three questions were formulated:

- Are the drivers following the advice presented while the system is enabled and is the speed decreased by it?
- While the drivers follow the advice, will the system decrease operative wastes as waiting time at the load area/bottleneck of the operation by driving slower?
- Is the fuel consumption less with the system than without?

In the two test configuration operations, actual speed and recommended speed were measured and compared. But a strict analysis of the difference in between the values is not a fair comparison. The system implemented did not fully consider all the physical constraints and variations in the advised speed. Due to the implemented HMI using only a visual interface there were a slight deviation in how accurate the drivers manage to follow the advice. But since the main purpose was to decrease waiting by decreasing speed the average speed should anyway be lower with the system than without. In Table 1, the average speed used for the haulage is presented. Since the hauler transports material one way and goes empty the other the names Loaded and Unloaded is used. Loaded is referring to the haulage with mass material in the tipping body. As seen the actual speed was in between 25 to 40% less while using the system. This can be considered as a general proof that the drivers was following the advice given in a reasonable good way.

Table 1 Average speed used for the haulage activities

	Speed Without System (km/h)		Speed With System (km/h)		Change (%)	
	Loaded	Unloaded	Loaded	Unloaded	Loaded	Unloaded
Hauler 1	28,8	29,6	17,7	17,5	-38%	-41%
Hauler 2	24,3	24,5	17,0	18,4	-30%	-25%
Hauler 3	27,0	29,0	16,7	16,8	-38%	-42%

The second question is answered in Table 2. The bottleneck causing waiting times was the loading area. While we compare the idle times we can see a decrease for all machines while following the advice and driving slower. The definition of the idle time used is the time to enter an area surrounding the load position triggered by a geofence to until the loading starts, which include the initial maneuvering to the load position and waiting at the load position. A geofence can be described as a virtual fence of geo positions defining an area, while crossed a triggering condition can be set. Due to this approach, the idle time cannot be zero, but kept to a practical minimum avoiding waiting times.

Table 2 Timing comparisons at loading activity

	Without system (s)			With System (s)			Change (%)	
	Total Load activity time	Load time	Idle Time	Total Load activity time	Load time	Idle Time	Load Time	Idle Time
Hauler 1	168	93	75	142	94	48	1%	-36%
Hauler 2	179	82	96	134	87	47	6%	-51%
Hauler 3	196	86	110	130	87	43	1%	-61%

The comparison between the test setups shows a decreased fuel consumption that differed in-between the operators and machines while enabling the system. In Table 3, fuel savings per machine and total accumulated fuel in % are presented comparing the base line cycles with the system enabled cycles.

Comparing sensor data over three cycles without system and with system shows a fuel reduction by up to 20% for one vehicle. But the savings differ and one vehicle only had 6% fuel savings.

Table 3 Fuel Savings in %

Hauler 1 average fuel saving/cycle	15%
Hauler 2 average fuel saving/cycle	6%
Hauler 3 average fuel saving/cycle	20%

## CONCLUSIONS & DISCUSSION

The purpose with the optimization system described is to minimize operative waste in an iterative haulage operation by decreasing speed using a decentralized system solution. The optimization needs to be done in a way that does not decrease the overall production rate. Since the production rate is defined by the process bottleneck in the theory of constraints (Goldratt, 1990), the bottleneck uptime and production need to be ensured. In the test performed the production rate i.e. bottleneck was defined by the loader. Relatively the loading capacity the haulers then had an over capacity. The operative wastes addressed by the system were then mainly waiting time performed by the haulers at load area. While used, the system successfully decreased the waiting time by adjusting speed during travel towards a future estimated JIT arrival. The decrease was done by reducing the waiting time before the loading activity, where waiting for the previous hauler was performed.

Since different drivers were used and asked them to drive freely during the cycles where the system was not giving advice on speed, the driver performed differently. What was clear was that the driver that had the least average speed and speed difference in between the cycles also had the least fuel saving in average.

The system effectively managed the minor deviations in actual activity timings such as travel times and loading times during operation and continuously updated and adjusted JIT data for its purpose. Real life savings in the test cycle configuration have been presented based on the tests performed. The

system relies on available and accurate wireless communication to continuously exchange operational data so that all machines can adapt to deviations and changes made.

### FUTURE WORK

The assessment presented show how a cyclic load and haul operation where the loading activity is the operation bottleneck can be optimized through a decentralized scheduling system. The test configuration shows that a system can be designed that manages natural deviations caused by the operators to decrease waste and save fuel. In the test cycles performed only minor driver based deviations were managed. More tests are required to manage larger deviations in connectivity, and operative changes such as route changes and unexpected breaks. Further the system architecture and the overall scheduling algorithms and timing detection systems will be investigated.

Further validations of the system by longer tests in real world environments are required to ensure that the operative changes done are captured and used effectively in the optimization calculations.

While the optimization is performed the approach taken in this paper is an assistive advice that is presented to the driver. A future improvement could be to integrate the speed advice into a control system that control the speed and driveline to further optimize its performance towards JIT arrivals.

### REFERENCES

- Goldratt, E. M. (1990). *Theory of constraints*: North River Croton-on-Hudson, NY.
- Hartenstein, H., & Laberteaux, K. (2010). *VANET Vehicular Applications and Inter-Networking Technologies*: Wiley.
- Pasternak, M., & Marshall, J. A. (2016). On the design and selection of vehicle coordination policies for underground mine production ramps.
- Prevot, T. (2002). Exploring the many perspectives of distributed air traffic management: The Multi Aircraft Control System MACS. Paper presented at the Proceedings of the HCI-Aero.
- Rylander, D., & Axelsson, J. (2013). Lean method to identify improvements for operations control at quarry sites. Paper presented at the ISARC Conference, Montreal.
- Rylander, D., Axelsson, J., & Wallin, P. (2014). Energy savings by wireless control of speed, scheduling and travel times for hauling operation. Paper presented at the Intelligent Vehicles Symposium Proceedings, 2014 IEEE.
- Switkes, J., Boyd, S., & Stanek, G. (2014). Driver-assistive Truck Platooning And Highway Safety: Features for drivers, fleet managers and highway officials. Paper presented at the ITS World Congress, Detroit, USA.
- Tetreault, C. B. J. (2005). Use of the Automatic Identification System (AIS) for maritime domain awareness (MDA). Paper presented at the OCEANS, 2005. Proceedings of MTS/IEEE.

# MINE AUTOMATION AND IMPLEMENTATION OF INNOVATIVE TECHNOLOGY: A REVIEW IN INDIAN CONTEXT

Narendra Kumar Nanda<sup>1</sup>, \*Shailendra Kumar<sup>2</sup>

*NMDC Limited, Khanij Bhawan,  
Masab Tank, Hyderabad-500028  
Fax -+91-40-23538705*

*(\*Corresponding Author: ritishailendra@gmail.com)*



**24th World Mining Congress**

MINING IN A WORLD OF INNOVATION

October 18-21, 2016 • Rio de Janeiro /RJ • Brazil



## MINE AUTOMATION AND IMPLEMENTATION OF INNOVATIVE TECNOLOGY: A REVIEW IN INDIAN CONTEXT

### ABSTRACT

The last few years and the foreseeable future appear to be a plateau stage in the growth cycle of mining mechanization. New control technology has improved the equipment designs; Microcomputers have improved energy efficiency, availability and productivity while reducing mining and maintenance costs. Geo-techniques have helped in improving the Mine designs.

Remotely controlled Mining operation is the future. Mine operations in the Pilbara, Australia are poised to be controlled from 1,300 km away at a new Remote Operations Centre (ROC) in Perth.

India is still in the nascent stage of mine automation and full mechanization of operations is still a mounting task even for big miners. NMDC, in its consistent approach towards mechanization, has installed single flight downhill conveyors capable of negotiating vertical and horizontal curves in its two newly commissioned mines. A movable trolley is installed at its triangular gantry for repair and maintenance. It has reduced man power requirement and substantially decreased energy and power consumption. Elimination of transfer points have resulted in increased Lump recovery.

This paper focuses on relevance of mechanization and automation in mining industry in India and authors will try to substantiate the tangible and intangible benefits thereof with computation and comparison of life cycle costs of bulk material handling systems, e.g. Downhill conveyors.

Key words: Life Cycle cost, Single flight downhill conveyor, intelligent truck fleet, Remote Operating Centers

## INTRODUCTION

Mining is among one of the oldest industries. Since pre-historic ages, the humankind has been carrying out the mining activities in various forms. The minerals and materials so extracted have been a major contributor to the development of the humankind. However, it is also a fact that the mining industry has been labor intensive. As the minerals and minerals were found in the very remote and underdeveloped locations and they were utilized on the locations which are very far from where they are extracted. This has left the industry very far from the mainstream and there has not been much technological advancement in the industry as a whole and it has been lagging behind as compared to the other industries. Although the industry has been contributing sufficiently towards the growth of the economies, it has not got the share it deserves.

During the last few decades, the importance of the mining industry has also been realized globally and there have been technological advancements on all fronts of the mining industry. However, this development also has been very uneven and the regions which are major contributor of the mineral resources have got fewer shares of the developmental aspects as compared to the regions. And we can still see that the industry as a whole is in its primitive stages.

There have been many reasons for the less technological advancement and innovation in the mining industry. The small scale of operations, easy availability of cheap labor in mining areas, less concerns about the safety and environmental aspects by the miners are some of the reasons of not going for the automation of mining operations.

This leaves us to think about the future of the industry in the present scenario. In today's world, technology is forever enhancing the way industrial goals are accomplished. Technology has changed the way we think; the way we assess problems and the way we work. It has given us tools to make our jobs more effective and efficient. The increasing global communication, awareness among the people, global agreements towards the health, safety, quality and environmental standards, increasing competitiveness, increasing labour cost all around the world etc has forced the miners to concentrate towards the more efficient technology and equipments and in turn the concept of complete automation is gaining importance. The use of technology to various aspects of the industry gives scope for the complete automation of the industry. Mining companies today are examining new technologies to maximize production, reduce costs, and create safer work conditions to deal with increasing future requirements.

In this background, we have tried to understand the status of automation in the mining industry, the requirement and the future in global as well as in Indian perspective.

## MINE AUTOMATION

Initially Automation was seen as a tool to maintain continuous safe production of mining plants. With time, this approach changed and automation was also seen as a way to increase efficiency and improve quality. Further, automation is now seen as a tool to Enhance mining operations by offering innovative solutions.

Remotely controlled Mining operations are gaining fast response and are supposed to be the future. The face of the mining world is poised for a metamorphosis in its outlook and productivity while achieving Zero hazard potential. The companies are thinking of smart mining systems where all the activities would be automated involving minimum direct human involvement and controlled from the remote centers. This will provide safer working environments with decreased hazard potential.

The mine automation consists of the automation of the various segments of mining operations and integrated monitoring. There are technological developments in each and every segment of mining operations. The technologies have been improved and now available for automation of either a particular segment or the operation as a whole.

## Benefits of Automation

Automation provides scope for better utilization of the existing resources. It enables us to obtaining maximum output from the minimum additional efforts. The mine automation ensures more efficiency within the existing system.

Some of the benefits of mine automation can be explained as-

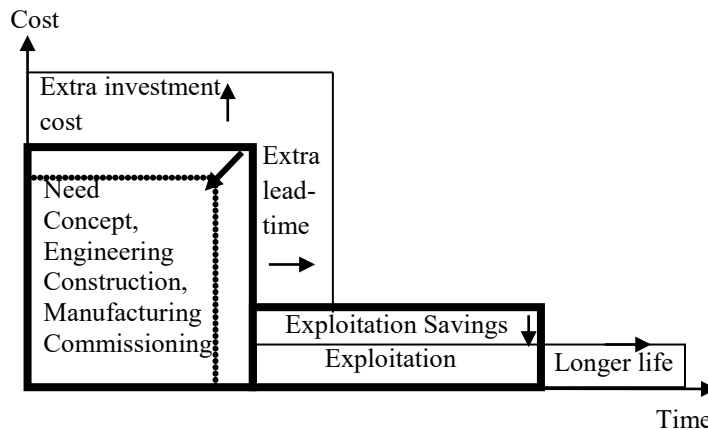

- Efficient industrial plants,
- Improved product quality
- Efficient monitoring,
- Timely product availability,
- Improved employee safety,
- Corporate flexibility, and
- Delivery performance
- Minimum maintenance
- Sustainable operations

## Automation in surveying activities

Surveying is the basic part of the mining activity. In open cast mines, It involves the face survey, stockpile survey etc. it has always been a time taking activity. Now days, use of drones to assess the quantities and map the areas is gaining importance. This has improved the efficiency and decreased the human effort.

## Automation in drilling

Drilling in the surface Mines is a highly concerned activity for mining engineers. No matter what type of mining – Whether it is surface coal or hard rock mining, or quarries blast-hole drilling pays a tantamount role because it initiates the production sequence. Everything downstream the drills – loading, material handling, crushing, etc. is affected by their performance.

The limitation of current drilling technology often restrict

- a) the cost – effectiveness of blasting and, hence,
- b) over all mine productivity and profitability
- c) Environmental friendliness of the mining activity.

With labour costs already high and steadily rising, highly-mobile and versatile rigs which can drill at least two, but preferably three or four blast holes simultaneously are coming up. There will also be an increasing need for such multi-boom rigs for drilling angled blast holes of medium diameter on the design final walls of open pits. .

In the last few years, top hammer blast hole drills have been gaining more ground in surface application(mainly in quarries) thanks to the straight- hole systems, which combine the high

penetration rates of top-hammer drilling with the sought after hole quality of DTH drilling. Thus Top-Hammer drilling system has allowed mining engineers to cut costs and reduce its fleet due to its high penetration rate low operating cost. In this system the hammer unit is at the top of the drill machine, and energy to the drill bit is transferred through the drill rod, minimizing the loss in energy transmission.

In the process of making drilling a environment friendly operation, recently Sandvik- Tamrock has tackled the problem of Noise and dust problem in drilling with supplying the drill machines which uses *shroud* that completely encloses a drilling rig's mast and due to its appearance it has been nicknamed 'The Great Pickle', The shroud would be easily detachable for allowing maintenance access to its various components.

Now days, as drilling advances, the performance-enhancing features such as GPS locators for the monitoring and control of rigs, strata-recognition systems and an assortment of mine management/equipment information systems are increasingly available. Operators are now having visual display in their cabs, data storage facilities and diagnostic systems.

Laser-profiling system and sophisticated blast design software packages that used to determine the best drill-hole locations, work well, but are rendered useless if the holes are not drilled in the right location. The exact drilling pattern (defined by fixed co-ordinates of the collars of holes) can be pre-programmed on a small desk-top computer. This information can be transferred to a microprocessor on the jumbo which then controls all boom and drill movements. In the case where a hole cannot be drilled in the planned position due to site issues, the driller can override the automatic mode and move the collar to the nearest suitable location.

There have also been improvements in operator's safety and comfort with ergonomically designed rig cabs, featuring reduced noise levels, reduced gas and dust emissions as well as array of amenities. And in the near future, promise of autonomous drilling cannot be ruled out.

### **Innovation in blasting technology**

Blasting has been transformed into a highly skilled discipline and detailed blast planning, modern explosives and sophisticated initiation systems have taken away much of the risk. However, designing an optimum blast has become a complex task. A well designed blast requires planning of the bench geometry with respect to the rock properties deciding on the preferred fragmentation with regard to grade control and handling properties and choosing the most suitable explosives as well as the detonation method and firing sequence. Furthermore, environment consideration have to be build in as legislation now sets limits for numerous side effects such as ground vibration, fly rock, dust, noise, gas pollution and air blast effects.

These environmental restrictions become the overriding design factors

- (a) in the case of many smaller mines and quarries
- (b) the blast has to be carried out near housing or other sensitive structures.

The advantage of the Bulk loading system is that the non-explosive components are transported by truck or trailer, mixed on site and sensitized whilst being loaded. This has the added advantage of reducing the need for the storage of explosives on site. The benefit of this arrangement is that the supplier becomes an integral part of the mining cycle when before, they dropped the blasting agents off at the magazine and left. Contract blasting programmes also allows all of the operations access to more sophisticated equipment, such as high-speed photography, laser profiling, fragmentation studies etc.

### **Automation in Dozers**

Laser control features on Geo-system's Dozer 2000 GPS-based machine guidance system is now being adopted to enable Dozer operators to see long-section and cross-section of slopes of dump on their display panel of the machine as it works. This high tech feature gives the much needed leverage to Dozer operators especially while working on the dump slopes and precarious terrains. The

cut and fill design files can be transmitted to the system via existing radio networks to ensure accurate downloading of data.

### **Driverless Automatic Truck Dispatch System**

Automatic truck dispatch system is a real time mine management system which continuously monitors the location and status of mining equipment and allocates the right truck at the right time to the right place. This system uses “State of Art” technology for automated data acquisition and communication. The location and movement of running equipment is tracked with precision GPS technology.

Field computer system are installed on mining equipments with touch screen, user friendly, graphical interface console for easy interaction with operators. Mine have used this system to achieve different objectives. Some users have maximized the fleet needed to maintain the production quota. Many mines are also using this system for grade control with blending in order to achieve consistency in the field to the process plant.

### **Automated driverless equipments**

This system is getting most importance in the mining industry. These systems work on totally automated system with auto programmed equipments which are controlled from a remote operation centre. Here the equipments are programmed for a particular operation and integrated with other systems so as to have a consistent working and defined output. As the human interference is minimal in this system, we can find the increased working hours and maximum utilization of the equipment.

Some of the big mining companies have already implemented the automated truck haulage systems and are working on automated driverless train operations.

### **Automated processing plants**

Low grade, complex mineral deposits require advanced processing techniques and sometimes, at the mine itself. This provides scope for advances process control systems to be installed. This results in high quality outputs which are easy to transport and store. Companies like Flsmidth and Metso minerals are coming out with such automated process control systems.

### **Automated Loading systems**

Systems such as rapid wagon loading and others result in better optimization of the activities in terms of precision and timings. These systems result in least wastage of materials during loading and are more efficient. These systems are integrated to the existing system to provide better results. NMDC is in process of installing a rapid wagon loading system to its complexes which will increase its efficiency in iron ore loading in transportation.

### **Automated Material Transport Systems**

This is also an area which is very crucial to the industry. Sometimes, the mines are having sufficient capacity, but their transport system becomes a hurdle in catering to its requirement. The automated transport system such as Slurry pipeline system gives a scope to increase the capacity. This type of transport system is cheaper when compared to the other modes of transportation such as railways and roads. The most important factor is that the infrastructure cost in this type of transport system is very low compared to the infrastructure cost of other modes. NMDC is in process of constructing a 600 kms long slurry pipeline transport system for its iron ore.

### **Auto analyzers**

Auto analyzers are used for real time analysis of data for quality monitoring. These are installed at important locations and transfer points wherein they randomly analyze the specification of products and generate instant data for the particular elements. This reduces the human interference and errors in data analysis.

## PRESENT STATUS OF AUTOMATION IN MINING

Globally, the mining industry is in transformation stage. Initially being a labor intensive industry, focusing on traditional mining methods, the industry has now understood the requirement of the technological developments and is focusing upon the innovative technologies for more and more automation. The big mining companies are transforming their activities towards more automated operations and developing newer technologies for better efficiency and sustained operations. The focus is now on more efficient, safe, environment friendly and scientific mining. The companies are now focusing towards deeper level mining operations and even underwater mining operations. Thoughts are now being emerged about the space mining also.

The companies like Rio, BHP, Vale etc are focusing towards remote operations, unmanned automated equipments like driverless trucks and trains being operated from a larger distance called Remote operations centre (ROC). They are utilizing Drones for faster and accurate surveys, and even are planning for carrying out the mining operations through robots. GPS technology is being used for systematic fleet management system. The companies are focusing on automated drilling, automated blasting techniques, automated haulage, and automated loading operations.

Mine such as Kiruna (Sweden) is a classic example of automated operations. Drilling is remote controlled, with a remote operator drilling via a joystick. Remote control of loading and hauling poses another technical challenge. For the navigation of a 14 metre long, 100 ton loader inside the mine, there has been installed a revolving laser on top of the loader, with reflectors located on the walls of the drifts. Loading, hauling and dumping on the sublevels are now fully remote controlled from the control centre in the main office building on the surface. As a result, one operator can run three LHD loaders simultaneously, having to intervene only during loading, while the loaders can be operated continuously. Remote controlled trains are operation for further movement of ores.

Launched in 2008, Rio Tinto's Mine of the Future™ programme introduces next-generation technologies for mining operations that aim to reduce costs, increase efficiency and improve health, safety and environmental outcomes. The programme runs in conjunction with leading universities and organizations around the world, through Rio Tinto's Centres of Excellence. Recent milestones in the Mine of the Future™ programme include the US\$518 million investment in autonomous trains for the Pilbara iron ore rail network in Western Australia; and the testing and developing of new technologies in underground tunneling and mineral recovery.

### Review of Innovation and automation in Indian context

Although being a large producer of many minerals, India lags very far in terms of automation of mine operations. Mining operations are still done through traditional methods in most of the mines in India. Automation in Indian mining industry is in nascent stage. Some coal mining companies like Singrani Collieries Company Limited (SCCL) and some subsidiaries of Coal India Limited are using GPS based fleet management system. Some other mining companies are also in process of implementing some latest equipments and techniques for process improvement. NMDC, being the iron ore mining major is front runner and has started process for introduction of newer technologies in its working and under construction mines. NMDC is gradually focusing towards automation of its mining operations and incorporating various automated practices into its operations.

M/S Rio Tinto and M/s iGATE have recently opened a state-of-the-art innovation centre in India to support global growth and development of Rio Tinto's industry-leading mine of the Future™ programme. In the first partnership of its kind in the mining industry in India, over the next five years iGATE Patni will provide Rio Tinto with engineering research and development services, including industrial automation and control, software and embedded design and development, and general engineering services.

### Scope of Automation in Indian Mining Industry

- Simulators – for training and safety
- GPS based fleet management system
- Automated Truck haulage system
- Regenerative conveyor systems
- Remote and Robotic operations
- Use of Remote Sensing / GIS systems
- Use of Drones for various activities
- Efficient material transport systems

### NMDC (A Navratna Public Sector Enterprise Under Ministry of Steel, Gov. of India)

NMDC is the single largest iron ore mining company of India with total installed capacity of 48 million tons per annum. It is supplying the one of the best quality iron ore to domestic and international customers. NMDC has been pioneering in the implementation of newer technologies in the Indian mining industry. It's all mining complexes are fully mechanized. The OCSL system is an integrated system consisting of processes of crushing, screening and loading facilities.

NMDC is in process of increasing its capacity to more than 100 million tonnes in next decade for which it has charted out a strategic management plan consisting of opening of new mines, increasing the capacity of existing mines, optimizing the operations, adapting to the newer technologies, shifting the operations towards more automation of activities etc.

NMDC, as a part of its IT implementation strategy it has introduced a no of softwares for process improvement. Presently NMDC is having following softwares.

- Simulators for training on dumpers
- MapInfo
- Isatis – Geostatistics
- Surpac – Mine planning
- Minesched
- Whittle
- ERP – under implementation

Having our vision to seamless transition of data from Borehole to Boardroom, NMDC has taken fledgling step and started trial of the software platform wherein data/information reporting will be done from mines to corporate office in real time basis.

NMDC has commissioned a new mine Kumarswamy iron ore project in Karnataka State during 2015. One of the unique features of this project is the 5.0 km long single flight conveyor system which is very different from the conventional conveyor systems. This is an innovative system conceptualized by NMDC keeping in view the project location and resource optimization.

### Features of Single Flight Conveyor System Installed at NMDC

- Five Km long, single flight Downhill conveyor
- Can negotiate horizontal as well as vertical curves
- Higher speed (relatively fast compared to normal conveyors)
- Triangular light weight gantry
- No walkway along the conveyor
- Self propelled maintenance and inspection trolley
- Variable speed drive system

### Technical Parameters

• Conveyor Design tonnage	:	2000 T/H
• Conveyor Rated Capacity	:	1800 T/H
• Conveyor Length	:	4876 m
• Material conveyed	:	(-)100mm Iron ore
• Conveyor Belt Width	:	1050mm
• Belt Design Width	:	6.0 m/s
• Belt type & Class	:	Steel Cord, ST 3150
• Motors	:	2 Nos; 800kW each with VFD
• Drive Pulley dia	:	1400 mm
• Total torque available	:	260.8 KNm
• Brake Disc Diameter	:	1800 mm
• Max Brake actuation time	:	0.03 sec
• Take up system	:	Horizontal
• Operating Capacity	:	1800 T/H
• Operating hours/annum	:	4000 Hrs

### Advantages:

- By using horizontal curves, conveyor with single flight is made possible and intermediate transfer points at turnings have been avoided. By making it single flight, following have been eliminated -
  - a. Power supply to different stations at intermediate points
  - b. Water supply
  - c. Access roads to transfer towers
  - d. Manpower in all shifts at remote transfer points in the forest
  - e. Procurement of additional land for transfer houses, mainly forest land involving tree cutting,
  - f. Wear out of intermediate chutes, chute jamming, risk at remote locations,
  - g. Additional security etc.
- Being a single long conveyor, the power requirement is much lower than in case of having 3- 4 sections which could require more power.
- Designing of smaller straight conveyors in hilly terrain require larger area for corridors and intermediate spots with required slope for transfer houses thereby increasing the length of conveyor system.
- The Triangular pipe gantry design is lighter as compared to the conventional rectangular structural gantry. The design being lighter saved initial cost and fabrication work.
- The triangular pipe gantry adopted is an open construction (to provide for trolley movement) eliminating larger enclosure of the complete gantry. This has reduced wind load on the supporting structure thus saving initial cost; it also enabled the conveyor to be designed comfortably with taller supporting structure especially across deep valleys, hilly terrain etc (The conveyor has been taken at a height to avoid interference of local structures, avoiding possibility of theft and sabotage, being a public area.)
- Better energy realization (regeneration) in view of overall reduction in the number of ups and downs
- Being open design, it affords better view of total length leading to better conveyor maintenance and aesthetics. It is also possible to ensure that the installed CCTV cameras are more effective.
- Very less number of idlers both on the carrying side and on the return side, resulting in less maintenance.
- The power flow is bidirectional i.e. power both for starting and running and also the power generated by the conveyor during running at load can be effectively pumped back to the grid.
- The System is an optimized solution with minimum land usage and environmentally better acceptability.



### **Life Cycle Cost Analysis Of The Conveyor System W.R.T. Conventional System**

To compare the life cycle cost of each potential conveyor configuration, an objective function that sums the annual equivalent cost of both operating and capital costs over the design life of the system was derived from the work of Roberts et al. The objective function takes into consideration the annual energy cost and annual equivalent costs of major conveyor components over the design life of the system, taking into account component life, inflation, taxation rate and rate of return on investment.

#### Operating Costs

Operating costs for a belt conveyor system include energy consumption, repairs and maintenance, and labor costs. While it is acknowledged that repairs and maintenance, and labor costs of other components can be significant, to the authors knowledge limited research has been published on the influence of factors such as belt speed and width, idler roll diameter and spacing, and troughing configuration on these costs.

The other operating cost considered in the analysis is the energy cost per annum, and is calculated from the actual power consumption of the belt conveyor.

#### Capital Costs

The cost functions used have been modified to allow for additional variables such as, idler roll diameter and load, and the influence of belt width on structural costs. Furthermore, rather than linear relationships between variables, current costing data showed power relationships modeled the cost functions more accurately. The annual equivalent cost functions for a number of major capital items are given below at Table-1.

Table 1 -TYPICAL LIFE CYCLE COST ANALYSIS FOR INSTALLED DOWNHILL CONVEYOR AT KUMARASWAMY MINE

Sl. No	Description	SINGLE FLIGHT CONVEYOR	CONVENTIONAL CONVEYOR
1	CAPEX (thousand US\$)	16911.76	20588.24
2	Salvage value (@10 % of 1) (thousand US\$)	1691.18	2058.82
3	Depreciation Value (1-2) (thousand US\$)	15220.59	18529.41
4	Estimated life in hours	175200.00	175200.00
5	No of working hours/annum (300 days 18 hrs/day)	5400.00	5400.00
6	No of scheduled hours /annum (300 days 24 hrs/day)	7200.00	7200.00
7	No of years for depreciation	20.00	20.00
8	Hourly owning cost		
(i)	Hourly Depreciation (US\$)	86.88	105.76
(ii)	Average annual investment (% of total investment)	52.50	52.50
(iii)	Average annual investment (thousand US\$)	8878.68	10808.82
(iv)	Hourly interest,insurance,taxes on investment (@ 8% on (iii)/6) (US\$)	98.65	120.10
(v)	Hourly owning cost ( i + iv) (US\$)	185.53	225.86
9	Hourly Operating cost		
(i)	Gain due to electricity regeneration (US\$/KWH)	44.12	26.47
(ii)	Lubrication cost (10% of i) (US\$)	4.41	2.65
(iii)	Annual AMC Cost (Spares, repairs & maintenance); 2.3% of capex for Single flight and 4% OF Capex for conventional (thousand US\$)	388.97	823.53
(iv)	Hourly AMC Cost ( US\$)	54.02	114.38
(iv)	Operators wages per hr (Rs)	8.06	20.15
	Hourly operating cost (US\$)	22.38	110.70
10	Hourly owning & operating cost ( US\$)	207.90	336.56
11	Life Cycle Cost (thousand US\$)	53336.42	79553.57

Assumptions taken as-

1. Life of the conveyor - 20 years
2. Average annual employee cost @us\$ 11765
3. No of employees for conventional system is 15
4. No of employees for conventional system is 8

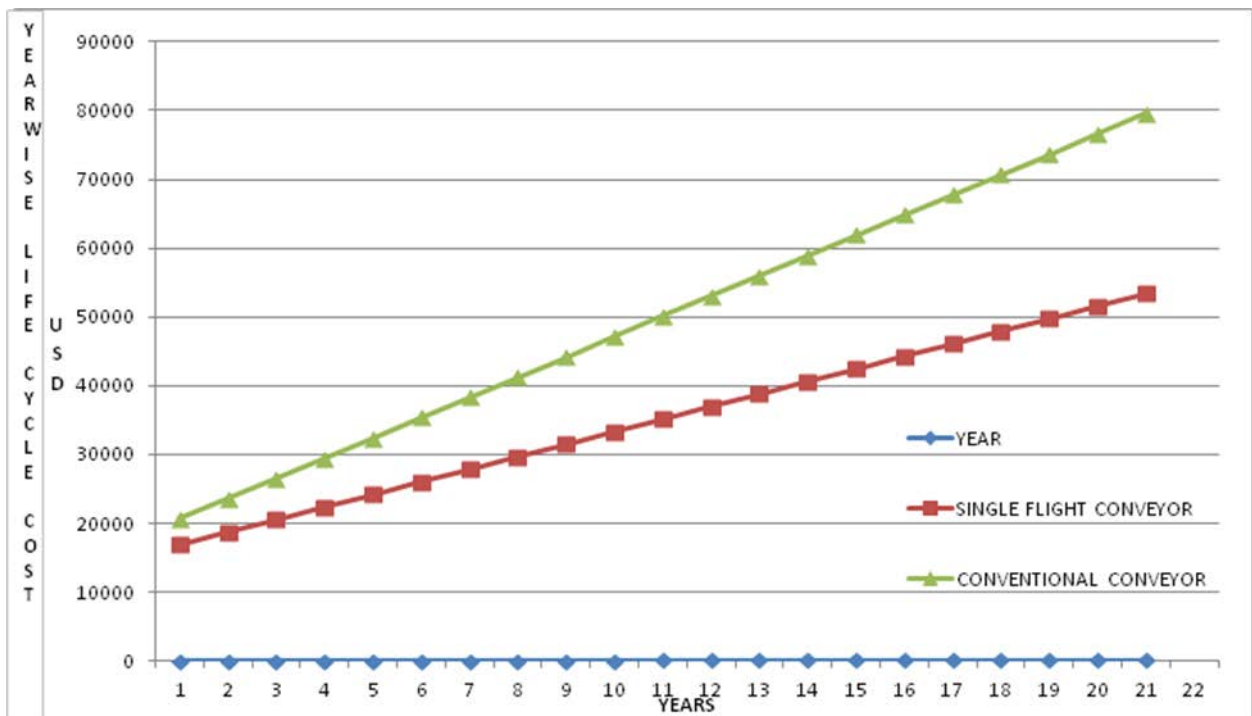

Figure 1 -From the above graph in Figure 1, it is very clear that there is a substantial amount of saving every year in the single flight system as compared to the conventional system. This amount is increasing every year and reaches its maximum at the end of 20<sup>th</sup> year.

### Future Planning

NMDC is in process of opening up of new mines with higher capacities and also increasing the capacity of its existing mines. We are planning to have more automated systems in the new mines. In the mines commissioned during last year we have installed the state of the art conveyor systems. In our future projects we are planning to go for better systems as it will be easy to implement in the new mines. Our new mines will have latest systems and advanced equipments. To have a proper surveillance on its mine boundaries, NMDC is planning to introduce a LASER controlled surveillance system in its mines.

NMDC is also planning to introduce GPS based fleet management system, Integrated Mine Management System, ERP system and a no of other innovative techniques best suited for its business planning and improvement.

### CONCLUSION

Automated systems increase productivity and efficiency, thereby making projects more economically feasible. With the implementation of automated systems, vehicle maintenance is more predictable and better-controlled. Understanding the social, environmental and economic issues surrounding automation and its contributions to the extractive industry will make a mining project more successful. The application of automated systems will improve the quality of work for employees by reducing exposure to unhealthy or unsafe environments, and will provide opportunities for training and capacity-building. These systems are also eco-friendly and obtain social support.

We can see that there is a huge scope of automation of mining operations in the Indian mining industry. Keeping in view the future demand of minerals in the country, we expect the improvement in the mining technology and subsequently a paradigm shift in the operations from manual to fully automated systems. NMDC has always been a pioneer in the Indian mining industry, and will continue to be a leader by adopting state of the art technologies. Now, we are already on the path of automation of our operations and see a better future.

### ACKNOWLEDGEMENT

Authors are thankful to Smt. Bharthi S Sihag, CMD, NMDC for her permission to present this paper at World Mining Congress, Rio De Zenerio, Brazil.

### REFERENCES :

1. *Indian Minerals Year Book 2014*
2. *“Application of LCC techniques in selection of mining equipment and technology” Markeset T and Kumar U., School of Science and Technology, Stavanger University College, Stavanger, Norway & Luleå University of Technology, SWEDEN, In proceedings of 10<sup>th</sup> MPES Symposium, Athens Greece, Nov. 6-10, 2000, pp 635- 640*
3. *DPR of Bailadila Iron Ore deposit No. 11B, Prepared by NMDC Limited*
4. *DPR of Kumaraswamy Ore deposit, Prepared by NMDC Limited*
5. *Website of Indian Bureau of Mines, Government of India*
6. *Website of Ministry of Mines, Government of India*
7. *Websites of Rio Tinto and Kiruna Mines*

\*\*\*\*\*

*Disclaimer: The views expressed in the paper are that of the author and does not represent that of the organization in which he is working.*

# TELERESCUER – AN INNOVATIVE ROBOTIZED SYSTEM FOR SUPPORTING MINING RESCUERS BY INSPECTING ROADWAYS AFFECTED BY CATASTROPHES

\*Wojciech Moczulski<sup>1,3</sup>, Krzysztof Cyran<sup>2,3</sup>, Marcin Januszka<sup>1</sup>, Petr Novak<sup>4</sup>, Anna Timofiejczuk<sup>1</sup>

<sup>1</sup>*Politechnika Śląska, Instytut Podstaw Konstrukcji Maszyn  
ul. Konarskiego 18A, 44-100 Gliwice, Poland*

(\*Corresponding autor: [wojciech.moczulski@polsl.pl](mailto:wojciech.moczulski@polsl.pl))

<sup>2</sup>*Politechnika Śląska, Instytut Informatyki  
ul. Akademicka 16, 44-100 Gliwice, Poland*

<sup>3</sup>*SkyTech Research Sp. z o.o.  
ul. Konarskiego 18C, 44-100 Gliwice, Poland*

<sup>4</sup>*Vysoká Škola Báňská – Technická Univerzita Ostrava, Katedra Robotiky  
17. listopadu 15, 708 33 Ostrava-Poruba, Czech Republic*



**24th World Mining Congress**

MINING IN A WORLD OF INNOVATION

October 18-21, 2016 • Rio de Janeiro /RJ • Brazil

## **TELERESCUER - AN INNOVATIVE ROBOTIZED SYSTEM FOR SUPPORTING MINING RESCUERS BY INSPECTING ROADWAYS AFFECTED BY CATASTROPHES**

### **ABSTRACT**

The paper deals with an innovative system for inspecting coal mine roadways, especially those affected by catastrophes such as fire, explosion of methane or coal dust, and the others. The solution relies upon the development of a respective software and hardware that allows virtual teleportation of a mining rescuer to those areas of a coal mine, in which he could not remain due to hazards for life or health caused by such factors as: explosive atmosphere, toxic gases that do not allow entering the zone without respective equipment, excessive temperature, hazard of reoccurrence of the same catastrophe etc. The system is composed of four basic parts: an unmanned vehicle (UV), a sensory and camera subsystem (SCS), a communication system (CS), and a control station located in a fresh-air base, which allows virtual teleportation (VT). An important element of the system is Main Control System (MCS), which provides control of the robot and its parts in two modes: teleoperated and autonomous. The UV is in fact a mobile robot of high mobility, which is capable of traversing complex obstacles to be met in a roadway after the occurrence of a catastrophic event. The SCS is carried by the UV and includes, between others, gas sensors that allow assessing composition of the atmosphere in the roadway inspected, and video and IR cameras with respective lighters. The CS is composed of two independent subsystems: fiber optic cable system, and wireless system basing on repeaters deployed by the robot to create the own communication network. The VT is realized by means of a highly innovative Human-Machine Interface (HMI). The majority of subsystems of the UV satisfy ATEX M1 requirements. The TeleRescuer system is developed now in the framework of the research project financially supported by the Research Fund for Coal and Steel of the European Union.

### **KEYWORDS**

Robotized inspection, mobile robot, remote control, autonomous operation, virtual teleimmersion, Directive 94/9/WE (ATEX)

### **INTRODUCTION**

In underground coal mines there can occur (possibly rarely) several kinds of catastrophic events such as: fire, methane explosions, CO<sub>2</sub> eruptions, and crumps. A part of the coal mine affected by such an event has to be sealed from the remaining excavations by means of a fire dam. Once people trapped by the event have been found and evacuated, the excavation usually remains closed until basic environmental parameters achieve values that allow entering the human rescuers into the area. This often forces the closure of the excavation affected for a long time, and simultaneously eliminates from the production the machinery and equipment remaining behind the dam. Furthermore, the excavation and its outfit become damaged, that results in significant difficulties when one is going to traverse the roadways and longwalls covered by debris of rocks and coal, destroyed parts of machines and installations, deep water obstacles, etc. Sometimes it may happen that the excavations will become fully clamped for lengths of up to several hundred meters (Szurgacz & Kasprusz, 2015).

To allow planning further operations concerning the given excavation it is required to carry out an inspection thereof as soon as possible, in order to establish an actual condition by acquiring photos, videos, maps, sketches, measurements of temperatures, taking profiles of compositions of the atmosphere including at least CH<sub>4</sub>, CO<sub>2</sub>, CO, O<sub>2</sub>, etc. Similar activities shall be performed in case of returning to operation such excavations that have been temporarily excluded and closed with respective dams. This task, however, is much easier to execute since in this case there will be no

unexpected obstacles in the roadways that could cause problems with the movement along the excavations.

Bearing all these prerequisites in mind, the authors identified the need to develop a robotized system whose goal would be to replace human rescuers by inspecting areas of a coal mine affected by catastrophes, simultaneously decreasing hazards that are faced with by the rescuers during their work. Furthermore, such a system could be implemented in explosive atmospheres and in environmental conditions that would not allow humans to operate, thus saving financial losses caused by long-term closures of roadways and longwalls armoured with costly machinery. This idea has become a background of long-term collaboration of a consortium whose aim has been to carry out the respective research, design and development of a complex innovative system for supporting mining rescuers by inspecting roadways affected by catastrophes under the acronym *TeleRescuer*.

This paper presents a conception and recent development of the *TeleRescuer* system and is composed as follows. A brief overview of known solutions is given. Then a general idea of the *TeleRescuer* system is presented. Further on, development of main parts of the system is outlined. Next, we deal with further work. The paper ends with conclusions.

## STATE OF THE ART

To allow the comparison of the conception of *TeleRescuer* system with known solutions let us briefly analyze the most essential aspects, which are: general application of robots for inspections in coal mines, mobility of UV, sensory systems applied, communication, map building, and human-machine interface (HMI) as well as teleimmersion.

### Inspecting Robots in Coal Mines

The usability of robots for inspecting closed areas of coal mines is recognized from several years. Research on inspecting robots is carried out by the Institute of Innovative Technologies EMAG, Katowice, Poland, and the Industrial Research Institute for Automation and Measurements (PIAP), Warsaw, Poland (Kasprzyczak, 2015). The prototype weights approx. 1000 kg and is capable to operate up to 2 hours. The system conforms to ATEX M1 requirements. First successful tests of the robot have been carried out in spring 2015.

Inspecting robots are also developed in China. An example is *Kaicheng* (2013), a robot that is capable of traversing very difficult obstacles. The robot is a tracked platform with adjustable auxiliary tracks. That combination provides very good off-road performance and obstacle overcoming ability. The chassis is designed as explosion- and water-proof and thus is suitable for the rescue site of underground coal mines. The robot is sealed by static and dynamic method. The robot passed the water-proof test. UV is equipped with infrared camera, which can catch clear picture at even EVO illumination. The computer communicates with the robot through an optic fibre with the length up to 1300 m.

### Solutions concerning mobility

Two main solutions are applied: wheeled robots and tracked robots. A wheeled UV usually has rigid axles or simple independent trailing (sometimes pushed) swing arms and almost exclusively even number of wheels. Steering is based on counter-rotation or different speed rotation of the left- and right-side wheels. The most popular wheel arrangements are chassis equipped with 4 or 6 the same sized wheels. The main determinant factor of off-road ability is the wheel diameter to obstacle size ratio. When obstacles are relatively small if compared with the wheel size, the wheeled vehicles can move efficiently even in rough terrain.

Tracks are often used in a rough terrain. Tracked robots can be classified by the track arrangement: fixed or adjustable where the whole track unit can rotate on common axis with sprocket. In case of adjustable tracks, the most common designs are: only front or front and rear turnable tracks. When front and rear tracks are adjustable, there is no need for main fixed tracks. Other, more complicated arrangements can be seen in some research projects, but there is no viable commercial solution.

Finally, hybrid designs are applied in which tracks complement wheels. Most of time the locomotion is based on wheels due to higher efficiency. Tracks come into contact with a ground only when UV encounters obstacles or a rough terrain. One of main disadvantages of this design is a ratio of chassis width to the width of the complete robot. Other potential problem is different linear speed of track and wheel circumference, which can cause additional resistance in soft terrain.

### **Sensory systems and cameras**

The main goal of inspecting robots is to measure and report contents of the atmosphere in a roadway, and to take images and/or movies that could allow assessing condition of the roadway after closing caused by a catastrophic event. This equipment is critical to the mission, thus has to work regardless the environmental conditions.

Gas sensors are used to identify risks related with explosion (presence of CH<sub>4</sub>, aka firedamp), with fire (several indicators, among them CO, HCl, some organic compounds, smoke particles) or with poisoning / suffocation risk (presence of CO, H<sub>2</sub>S, NO<sub>x</sub>, CO<sub>2</sub>, lack of O<sub>2</sub>). There are portable multigas sensors available. It is worth stressing that some gases shall be measured on definite heights of the roadway: CO<sub>2</sub> near the floor, while CH<sub>4</sub> by the roof. To this end, special effectors are required to lift sensors to the respective levels of measurements.

Further categories of environmental sensors are those needed for measuring physical quantities, like airspeed, temperature, and relative humidity.

Video cameras and infrared ones are additional categories, which have to operate in order to allow teleimmersion of the operator and to take images and videos from the operation scene. They have to collaborate with a lighting system that is necessary because of very poor illumination in the roadways affected. Furthermore, both types of cameras shall be capable of operating in an atmosphere contaminated by fog, smog or smoke, as well as coal and stone dust.

The latter category of sensors allows establishing the internal state of the robot's subsystems and its local environment. Some of them are used to allow the robot to detect obstacles. Other such as a laser scanner can be used for building 3D maps of the roadways and longwalls.

### **Communication systems**

The communication system depends on the bandwidth that is expected to be needed for the transmission of telemetry and video data, which sets the lower transmission rate limit in normal operation in the range of 100 Mbps. Two different approaches are used: wired networks and wireless ones. Wired networks can be arranged in a form of copper wired network: Intrinsically Safe Ethernet (Ex i Ethernet) (Fritsc, 2008), or Digital Subscriber Line / Very-high-bit-rate digital subscriber line (DSL / VDSL) systems (Westermo, 2010). However, copper-wired networks are now replaced by fiber-optic systems. A new approach is based on wireless networks. A ring topology is used for fibres, allowing the continuity of data transmission if one side of the ring is broken. Moreover, media converters allow the connection of other networking equipment, mainly Wireless (WiFi) access points. Such an ATEX networking gear has been developed in the framework of RFCS project IAMTECH (Rodriguez et al., 2009), resulting in first installation of full networks with wireless access in a coal mine in Germany. Nowadays it is commercially available.

### **Map building**

The source of data for 3D map building will be a 3D laser scanner. The 3D laser scanner can be composed from a commercial 2D laser scanner by adding a tilting mechanism. The suitable laser for a mining roadway must be able to measure black surface with very low reflection of the light, and in case of coal seam.

The result of that measurement is a point cloud. More point clouds can be combined together. This data structure is directly suitable for 3D map building. A special algorithm called voxelization can easily process a point cloud. This algorithm transforms points to small cubes, reduces and unifies



density of point cloud. The result of voxelization is similar to 2D map represented in a grid, composed from three types of small squares: representing free space, obstacles and unmeasured space. A 3D map can be efficiently represented by an octree (Hornung et al., 2013) (Dryanovski et al, 2010).

### Navigation

Navigation in an underground mine environment, especially after accident is a non-trivial task. There are many factors that make driving in that conditions very hard, does not matter if it is either tele-operated or autonomous operation. Damages to a roadway or longwall are causing complexity to the travelled track. Furthermore, there might be low visibility caused by fire or high humidity. Atmosphere can be filled with smoke and dust.

A standard sensor set in robotics for finding UVs orientation is an inertial measurement unit (IMU) that can measure velocity, orientation and gravitational forces simultaneously. It is the main component of inertial navigation systems used in an aircraft, spacecraft, watercraft, guided missiles and drones among others. In this capacity, the data collected from the IMU's sensors allows a computer to track a craft's position, using a method known as dead reckoning (Rishid, Turuk, 2015). In this case navigation must be based on internal sensors and takes advantage of an odometry. Odometry consists in using data from motion sensors and previously determined position to calculate the current position of the robot. There are few ways to acquire the needed data. The simplest way would be to use encoders mounted directly on driving wheels, but off-road conditions and high possibility of occurrence of the wheel/track slippage disqualifies that solution as too inaccurate. More advanced odometry systems are based on the inertial data collected from IMUs used also for finding UVs orientation. That data is independent from physical contact with the environment, but the accuracy is highly sensitive to sensors quality, which is exposed to drift.

### GENERAL IDEA OF THE TELERESCUER SYSTEM

After identifying the needs described above the authors in cooperation with employees of the Central Mining Rescue Station (CMRS) in Bytom, Poland have developed requirements for robotised inspection of coal mines (Timofiejczuk et al., 2015). In order to meet these requirements, we developed a general concept of virtual teleportation system for coal mine rescuers into areas affected by catastrophic events (Moczulski et al., 2015).

The goal of the TeleRescuer system (Figure 1) is to increase safety of operation of coal mine rescuers whose task is to inspect an area of a coal mine (e.g. roadway) affected by a catastrophic event. To this end, an unmanned vehicle UV is sent to the roadway affected, which is closed by a dam in order to isolate the area from the rest of the coal mine underground where normal production takes place. The vehicle is equipped with a corresponding sensory and camera systems to allow investigating the overall condition of the area affected. Due to teleoperation it is possible to direct the device to the roadway parts, which are inaccessible to observations. The data and images collected by UV are sent via an advanced communication system to the operator remaining in a safe place. Thanks to a very innovative human-machine interface (HMI) the operator-rescuer may be teleimmersed in the area where the UV just operates. A general idea of the TeleRescuer system can be explained as follows. The action of the robot takes place in a roadway affected by some catastrophic event. The robot is autonomous with respect to power supply. The basic mode of control the robot is teleoperation. The operator works in the Underground Operate Room (UOR). In general the data is transmitted to UOR by fiber optic communication system. It can be also available at the Command Centre above the ground, if necessary. However, a limited autonomy of the UV is also required in case of losing communication (e.g. broken communication cable). The UV plays a very important role in the system. Thanks to respective design corresponding to requirements of European Directive ATEX 94/9/EC, Equipment Category M1 (ATEX, 1994) the robot is capable of operating in an explosive atmosphere, regardless of CH<sub>4</sub> content. Since in the roadway affected by an explosion or fire there can be many obstacles making the movement of the robot difficult, the robot carriage has to be able to traverse diverse impediments. Some aspects of mobility are discussed in the next section.

### DEVELOPMENT OF MAIN PARTS OF THE SYSTEM

The TeleRescuer system is composed of the following main parts (Figure 2): mobile platform of unmanned vehicle, main control system, sensory and camera (vision) subsystem, communication system (wired and wireless) and human-machine interface on control station allowing virtual teleportation. Additionally, MCS contains components responsible for autonomous operation and 3D map building.

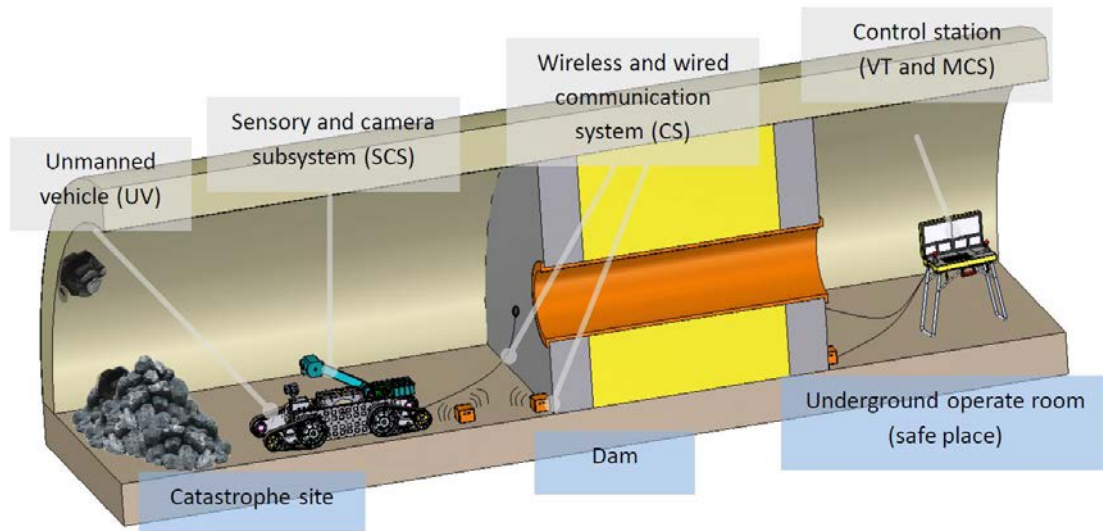

Figure 1 – Idea of the TeleRescuer system (courtesy M. Nocoń, SUT Gliwice, Poland)

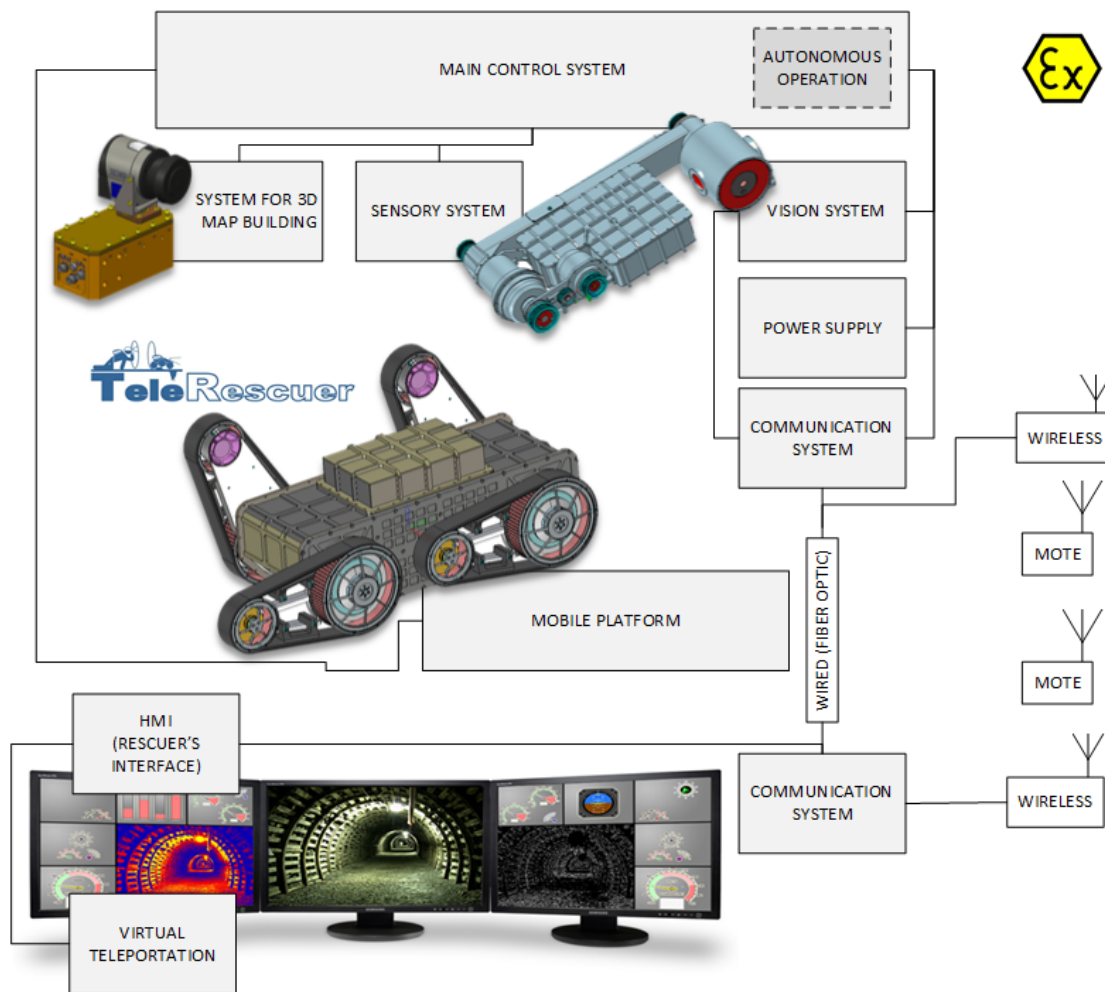

Figure 2 – Main parts of the TeleRescuer system

### Unmanned vehicle (UV)

There are several fundamental requirements that have been set by the team carrying out the project. They have been systematically identified in collaboration with end-users – coal mine rescuers. The following requirements are directing the development of the UV (Timofiejczuk et al., 2015):

- ATEX M1 design of as many systems as possible allowing operation in an explosive atmosphere;
- Ability to traverse through the dam with manholes of 800 mm diameter;
- Ability to overcome 90% of obstacles that leave the passage of similar dimensions to those of the UV;
- Independent power supply allowing operation at the distance up to 1 km from the mission starting point, with the necessity to return to the starting point;
- Speed of 0.5 km/h at even surface, with the ability to traverse slopes of up to 30%;
- Payload of 20-30 kgs (1 kg for the arm with cylinder).

Several conceptions of the UV have been created and then discussed and evaluated. Among others, four-wheeled robots, six-wheeled ones and other of different combinations of caterpillars and/or wheels have been analysed. The most promising conceptions have been modeled in Siemens LMS simulations environment and then carefully analysed in a virtual environment containing quite exhaustive repertoire of obstacles corresponding to real ones that have been identified by the rescuers. There were used three different types of obstacles: different arrangements of pipes of diameter 100, 150, 250 mm; series of thin beams and partitions; block obstacles. Finally, a complete longwall system has been modeled, which very often constitutes the scene of operation of the UV. These simulations

allowed the team to assess limits in mobility for each conception, and also to estimate and compare between the conceptions the amount of energy necessary to traverse the complete tour.

The developed four-caterpillar design of UV, presented in Figure 3, allows high manoeuvrability and possibility to equip the body with an actuator which would make possible to take gas profiles of the roadway by means of gas sensors attached to the tip of the actuator. Further on, an extensive lighting and camera system can be placed into the glass cylinder that may be lifted and simultaneously turned to allow better visibility of the area, while a 3D scanning system may be located at the upper surface of the chassis. Additionally, the mobility system chosen allows raising the main body of UV in order to make visible the elements obscured by obstacles. The solution adopted features eight DOFs to be controlled by the user (four angles of orientation of the tracks and four speeds of them). This requirement implies complexity of the control system and HMI, which has been tested in a simulation environment (initially in a robot simulator called V-REP) by means of manual controlling the UV by a gamepad. However, particular attention should be paid to the latter in order to allow controlling the device by a rescuer that could be trained by means of a simulator.

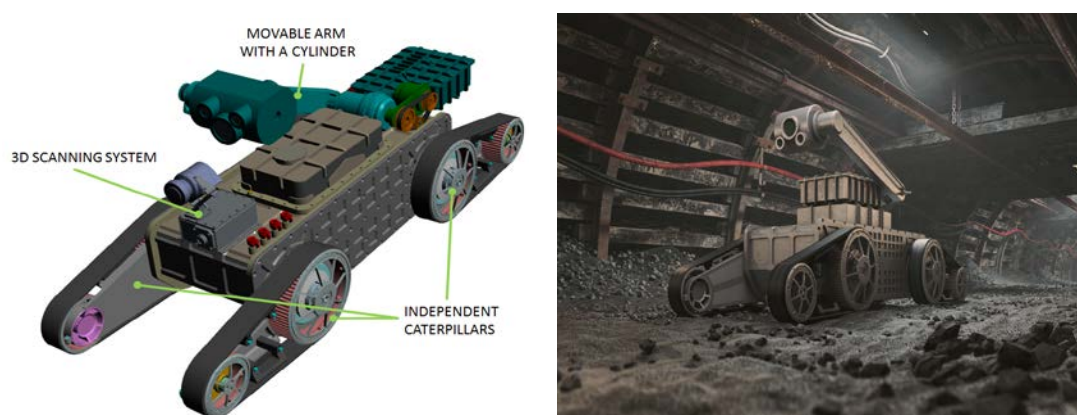

Figure 3 - Model and visualisation of the unmanned vehicle in its operational scene

### Main control system (MCS)

The Main Control System (MCS) of the UV is composed of several important parts. Controlling the motion of the platform is only one among several difficult tasks. All hardware components of the control system, including sensors and cameras, have to comply with ATEX M1 requirements. With proper simplification, the main tasks to be performed by the MCS are (Novak et al, 2015):

- Control of the motion of UV;
- Control of tilt and turn of the cameras and auxiliary lightning;
- Data acquisition from the sensory system and monitoring the environmental conditions (e.g. methane content);
- Data acquisition from the LIDAR and building 3D maps of the roadway passed (switched off in case of increased CH<sub>4</sub> content);
- Monitoring internal parameters of the system (power supply status, internal temperature of the chassis, temperatures of bearings and other more important tribological nodes, etc.);
- Autonomous operation in case of losing communication.

One of valuable functionalities of UV is the ability to build 3D maps that can be used for many purposes. The maps can be analysed by the commander of the rescue action in order to plan further activities. They can constitute an evidence for administrative or judicial decisions. Simplified 3D maps can also be used by MCS of the UV to allow limited autonomy of the operation while the communication has been broken down. To build maps, the robot will take laser scanner measurements with the use of the developed laser scanner presented in Figure 4, and then will calculate the map using

octrees. However, communication loss may occur in any time. To restore communication in case of losing it, the robot will return along its path using a simplified 3D map of the roadway it has passed. To this end, a real-time map building system is necessary. Taking into account limited computing power of the resources the robot is equipped with, the team is going to apply Cloud Computing Technology in which maps will be calculated by stationary computer(s) located in UOR, and then transmitted in the simplified form back to the robot. If the fiber optic link were unable to operate, it would be possible to reconfigure the software of MCS and carry out all the calculations concerning 3D maps directly by computing resources located on the robot. This reconfiguration, however, can cause dramatic reduction of the operation range of the robot, thus affecting its mobility.



Figure 4 – A laser scanner for 3D map building

The robot will feature a limited autonomy of operation that will be triggered mainly in case of losing communication. This mode of operation will be based on the 3D map (possibly simplified) stored in mass memory of the robot. The robot will take advantage of its sensory system (LIDAR, UV sensors, and the like) in order to identify its nearest environment and then comparing it with the map in order to plan its route.

Since rescue operations hopefully take place very rare, the robot can also be used for other activities such as a diagnostics of conveyers. To this end, the robot would move along the conveyer using the map of the roadway and could apply IR cameras in order to detect faulty rollers or other parts. However, such an operation requires full autonomy of the robot.

#### Sensory and camera subsystem (SCS)

Since the robot developed in the TeleRescuer project is focused on the virtual teleportation, the robot is provided with a sensory system for collecting sufficient data and signals for the remote assessment of the area affected by a catastrophic failure. Vision and sensors must meet the requirements of ATEX M1 directive because they are essential and must work in every situation. For environment measurements, the robot is equipped with sensors for different gases situated at levels specific to them:

- At ceil level (up to 3 m): methane (CH<sub>4</sub>);
- At face level (1.8m): carbon monoxide (CO), oxygen (O<sub>2</sub>), air flow, temperature/humidity;
- At ground level: carbon dioxide (CO<sub>2</sub>).

They are directly connected to MCS in order to send their measurements outside through the connected switch. Regarding the vision system, proper cameras were chosen by research team to supply an immersive experience. The robot is provided with the following cameras:

- Front cameras: One fish-eye camera, two cameras to build the stereoscopic vision, one thermographic camera using infrared radiation.

- Rear cameras: one fish eye camera.

The cameras are mounted within a special cylinder attached to a special actuator - an arm, which provides the necessary mobility of the sensor head.

### **Communication system (CS)**

Since the robot in general will be teleoperated, the reliability of real-time wideband communication will play fundamental role in operation of the complete system. Since two colour video streams of HD quality and one IR stream of a resolution of 640 x 480 bits, and 3D scanner measurements are to be transmitted simultaneously, a very high transmission rate is required. To this end, two independent communication systems will be applied:

- Fiber optic communication system (the basic comm system);
- Dedicated wireless communication system (the backup system, operating by the reduced resolution of the cameras and lower fps).

The robot itself will deploy both the communication systems. The robot will be equipped with fiber optic cable spool to be uncoiled when moving along the roadway. In such a way the friction of the fiber optic cable against the rocks and equipment located in the roadway will be practically eliminated. Wireless communication requires particular attention due to bad propagation conditions that are faced with in coal mine roadways. Therefore a special dedicated comm system working at 968 MHz is developed, which will take advantage of hardware repeaters (mots) that will be dropped down if excessive attenuation of the wireless signal will be encountered. Previous tests yielded results that WiFi network range was up to 100 m if the repeaters saw each other. The UV will carry up to 10 repeaters, which is sufficient enough for typical arrangements of roadways in coal mines.

### **Control station allowing virtual teleportation (VT)**

The interface of the rescuer plays extremely important role in the complete system (Moczulski et al., 2015). The most demanding requirement concerns virtual teleportation of the rescuer to the area where the robot operates, while in the same time operation of a human rescuer is forbidden or even dangerous. To this end, Knowledge-based Virtual Immersion of the Rescuer – KVIR™ is applied. Principles of operation of the rescuer's interface were subject of extensive consultations with professional rescuers. Unfortunately, using such pieces of hardware as caves, Head- Mounted Displays etc. is impossible in a real UOR conditions. Therefore, a simplified hardware presented in Figure 2 corresponds to expectations of rescuers. Hardware is based on three 3D computer displays arranged in such a manner that they surround the operator. This interface is fully configurable by the Administrator of the system. A default configuration (shown in Figure 2) gives the view of the roadway where the robot is operating. On the left hand a view of IR camera is shown, while results of 3D scanning are presented on the opposite screen. Moreover, readings of different sensors are presented. Equipment allowing better teleimmersion can be located in an underground command center. Since rescuers operate upon stress conditions, a knowledge-based component of the system is developed. Its goal is to provide the operator with the most important information he just needs, or which requires prompt assessment. A specific problem consists in selecting suitable controllers for steering the 8-DOF robot. Two kinds of controllers were analysed: custom aviation controllers (shuttlecock, and levers), and typical analog pads, familiar to computer users. The operator will be aided by intelligent software that will support her/him by controlling eight DOFs of the robot. Applying different pre-defined behaviours of the robot and then using special behavioural controller, which will be able to make fusion of behaviours, solve this. Furthermore, an intensive training will be offered to the operators using an advanced training simulator.

## **CONCLUSIONS AND FURTHER WORK**

The paper dealt with the general idea of a system for virtual teleportation of a rescuer to the area of a coal mine affected by catastrophic events. In order to carry out the work the consortium has been created with its leader – the Silesian University of Technology at Gliwice. The execution of the project has been started in July 2014. Nowadays, the work is carried out concerning basic elements of

the system. Virtual prototyping of the system's elements was used extensively, allowing for selection of an optimal solution to the mechanical carrier. The requirement to comply with ATEX M1 requirements significantly influences the design of the robot. Moreover, development of individual subsystems is advanced significantly, including: main control system, sensory and cameras (vision) system, communication system, human-machine interface allowing virtual teleportation. Future work will concern developing prototypes of all subsystems and their integration into fully functional TeleRescuer system. Then, the general approach and the system itself will undergo extensive tests in an environment very similar to the operating conditions of rescuers in a real coal mine. The rescuers will take part very intensively in the validation stage. Next tasks and objectives concern development of fully autonomous operation of the system and adoption of the technology to other applications requiring inspections carried out by unmanned vehicles and requiring explosion-proof solutions.

### ACKNOWLEDGMENTS

This work is partially supported by the Research Fund for Coal and Steel under the grant No. RFCR-CT-2014-00002, and by Polish Ministry for Science and Higher Education from financial sources that constitute the public aid in years 2014-2017 assigned for an accomplishment of an international co-financed project.

### References

- ATEX (1994). Directive 94/9/EC of the European Parliament and the Council on the approximation of the laws of the Member States concerning equipment and protective systems intended for use in potentially explosive atmospheres, <http://eur-lex.europa.eu/legal-content/EN/TXT/?uri=CELEX:01994L0009-20130101>
- Dryanovski, I., Morris, W., & Jizhong, X., (2010). Multi-volume occupancy grids: An efficient probabilistic 3D mapping model for micro aerial vehicles, Intelligent Robots and Systems (IROS), 2010 IEEE/RSJ International Conference, 1553-1559.
- Fritsc, A. (2008). Industrial Ethernet in process automation...and explosion protection?, Ex-Magazine, 10-19.
- Hornung, A., Wurm, K.M., Bennewitz, M., Stachniss, C., Burgard, W. (2013). OctoMap: an efficient probabilistic 3D mapping framework based on octrees, Autonomous Robots, 34(3), 189-206.
- Kaicheng (2013). *Underground Coal Mine Rescue Robot*. <http://www.ekaicheng.com/en/products/robots/20147281400154404.html>.
- Kasprzyczak, L. (2015). Mobilna Platforma Inspekcyjna na tle światowych rozwiązań robotów górniczych [Mobile platform for inspection on the background of global solutions of mining robots]. In: K. Krauze (Ed.), *II Konferencja „Mechanizacja, Automatyzacja i Robotyzacja w Górnictwie, Ustroń, 17-19.06.2015*. Łędziny: Centrum Badań i Dozoru Górnictwa Podziemnego.
- Moczulski, W., Cyran, K., Januszka, M., & Myszor, D. (2015). An innovative RTAR™ technology for inspecting areas inaccessible for human experts. In J. Mączak (Ed.), *XIV International Technical Systems Degradation Conference, Liptovsky Mikulas, 8-11 April 2015* (pp. 118-119). Warszawa : Polskie Naukowo-Techniczne Towarzystwo Eksploatacyjne.
- Moczulski, W., Cyran, K., Novak, P., & Rodriguez, A. (2015). Telerescuer - innowacyjny system przeznaczony do inspekcji wyrobisk kopalnianych dotkniętych katastrofą [TeleRescuer - an innovative system designed for inspection of coal mine affected by disasters]. *Inżynieria Górnicza*, No. 4, 50-53.
- Novak, P., Babjak, J., & Moczulski, W. (2015). Control System of the Mobile Robot TELERESCUER. *Applied Mechanics and Materials*, vol. 772, pp. 466-470.
- Novak, P., Bajak, J., Kot, T., Olivka, L., & Moczulski W. (2015). Exploration mobile robot for coal mines. In: J. Hodicky (Ed.), *Modelling and simulation for autonomous systems. Second*

*international workshop, MESAS 2015, Prague, Czech Republic, April 29-30, 2015* (Lecture Notes in Computer Science ; vol. 9055 0302-9743, pp. 209-215). Cham: Springer.

- Rashid, H., & Turuk, A.K. (2015). Dead reckoning localisation technique for mobile wireless sensor networks, *IET Wireless Sensor Systems*, 5(2), 87 – 96.
- Rodríguez, A., Schmid, M., & Winkler, T. (2009). *Increasing the efficiency of roadway drivages through the application of advanced information, automation and maintenance technologies*, ISBN: 978-92-79-11704-6.
- Szurgacz D., & Kasprusz A. (2015) Układy zabezpieczające stojaki hydrauliczne zmechanizowanej obudowy ścianowej przed przeciążeniami pochodzącymi od wstrząsów górotworu (in Polish). In: K. Krauze (Ed.), *II Konferencja „Mechanizacja, Automatyzacja i Robotyzacja w Górnictwie, Ustroń, 17-19.06.2015*. Łędziny: Centrum Badań i Dozoru Górnictwa Podziemnego.
- Timofiejczuk, A., Adamczyk, M., Moczulski, W., Mura, G., & Nocoń, M. (2015). Układ mobilny specjalistycznego robota do inspekcji wyrobisk kopalnianych dotkniętych katastrofą [A mobile system of specialized robot for inspection of coal mine areas affected by catastrophes]. In: K. Krauze (Ed.), *Mechanizacja, automatyzacja i robotyzacja w górnictwie* (pp. 66-74). Łędziny : Centrum Badań i Dozoru Górnictwa Podziemnego.
- Timofiejczuk A., Adamczyk M., Bagiński M., & Golicz P. (2015). Wymagania dla robotów uczestniczących w akcjach ratowniczych w podziemnych kopalniach węgla kamiennego [Requirements for robots participating in rescue operations in underground coal mines]. In: K. Krauze (Ed.), *II Konferencja „Mechanizacja, Automatyzacja i Robotyzacja w Górnictwie, Ustroń, 17-19.06.2015*. Łędziny: Centrum Badań i Dozoru Górnictwa Podziemnego.
- Westermo Wolverine WhitePaper (n.d.). xDSL technology, Retrieved on April 04, 2016, from [www.westermo.com](http://www.westermo.com).



# THE CHALLENGE OF WIRELESS CONNECTIVITY TO SUPPORT INTELLIGENT MINES

\*V. S. B. Barbosa<sup>1,4</sup> and L.U. Garcia<sup>1</sup>, G. Caldwell<sup>2</sup> and E. P. L. Almeida<sup>2,3</sup>, I. Rodriguez<sup>3</sup>, T. B. Sørensen<sup>3</sup> and P. Mogensen<sup>3</sup>, H. Lima<sup>4</sup>

*<sup>1</sup>Vale Institute of Technology  
Avenida JK, 31  
Ouro Preto, Brazil  
(\*Corresponding author: c0440610@itv.org)*

*<sup>2</sup>Institute of Technological Development  
SCS Quadra 01 Bloco F, Asa Sul  
Brasília, Brazil*

*<sup>3</sup>Wireless Communication Networks Section  
Department of Electronic Systems, Aalborg University  
Fredrik Bajers Vej 7 A3-A4, 9220  
Aalborg Øst, Denmark*

*<sup>4</sup>Ouro Preto School of Mines  
Campus Morro do Cruzeiro, s/n  
Ouro Preto, Brazil*



**24th World Mining Congress**

MINING IN A WORLD OF INNOVATION

October 18-21, 2016 • Rio de Janeiro /RJ • Brazil

## THE CHALLENGE OF WIRELESS CONNECTIVITY TO SUPPORT INTELLIGENT MINES

### ABSTRACT

The need for continuous safety improvements and increased operational efficiency is driving the mining industry through a transition towards large-scale automation of operations, i.e., “intelligent mines”. The technology promises to remove human operators from harsh or dangerous conditions and increase productivity, from extraction all the way to the delivery of a processed product to the customer. In this context, one of the key enablers is wireless connectivity since it allows mining equipment to be remotely monitored and controlled. Simply put, dependable wireless connectivity is essential for unmanned mine operations. Although voice and narrowband data radios have been used for years to support several types of mining activities, such as fleet management (dispatch) and telemetry, the use of automated equipment introduces a new set of connectivity requirements and poses a set of challenges in terms of network planning, management and optimization. For example, the data rates required to support unmanned equipment, e.g. a teleoperated bulldozer, shift from a few kilobits/second to megabits/second due to live video feeds. This traffic volume is well beyond the capabilities of Professional Mobile Radio narrowband systems and mandates the deployment of broadband systems. Furthermore, the (data) traffic requirements of a mine also vary in time as the fleet expands. Additionally, wireless networks are planned according to the characteristics of the scenario in which they will be deployed, but mines change by definition on a daily-basis. Therefore, a careful and continuous effort must be made to ensure the wireless network keeps up with the topographic and operational changes in order to provide the necessary network availability, reliability, capacity and coverage needed to support a new mining paradigm. By means of simulations, we analyze the effects on the wireless network along 7 years of constant topographic changes in an open-pit mine coupled with much higher data requirements. The authors also present a new network topology that is able to partially meet the requirements posed by mining automation and discuss the consequences of not providing connectivity for all applications. The work also discusses how the careful positioning of the heavy communications infrastructure (tall towers) from the early stages of the mine site project can make the provision of incremental capacity and coverage simpler.

### KEYWORDS

Mining automation, wireless communication, intelligent mines, communication requirements, mining application

### INTRODUCTION

The replacement of human labor by mechanical and electronic devices is not new in the industrial world. Specifically in the mining industry, which encompasses higher operational risks, process automation has the potential to ensure exploitation with higher levels of safety and efficiency. Autonomous equipment has been adopted to a greater or lesser degree in underground and surfaces mines. Although automated processes are well established in underground mines (such as the use of longwall shearers at coal mines), open-pit mines are still employing initiatives through pilot-projects for testing automation of loading and haulage equipment, as those working in mines like Gabriela Mistral (Codelco), Pilbara (Rio Tinto) and Bruccutu (Vale). Collaboration between equipment suppliers and mining companies are common to the development of these systems, often customized for the project in terms of volume and capacity (Bellamy & Pravica, 2011; Hargrave et al., 2007; Korane, 2013).

Monotonous and repetitive activities are immediate candidates for the automation process. There are natural candidates in open-pit mines, *i.e.*, operations whose automation is less challenging than others, such as the work of trucks (hauling the material from excavators sites to the dump area), drill rigs (drilling according to a previous mesh for loading explosives), bulldozers (working on haul roads and stripping areas), and water trucks (spraying water to reduce dust). On the other hand, the excavators are still far from being 100% automated, because there is a complex set of tasks that cannot be classified as monotonous and repetitive, currently requiring greater intervention of a human operator (Bellamy & Pravica, 2011; Garcia et al., 2016; Hargrave et al., 2007; Korane, 2013).

The common denominator of all applications that require connection of mobile field equipment to an Operational Control Center (OCC), for example a Mining Dispatch System (MDS), is wireless communications, as shown in Figure 1. The automation project will only be successful if the communications requirements are met by the wireless network. Depending on the task and the desired level of automation, these requirements will be more or less restrictive: for example, sending the mesh to the drill rig may be delay tolerant whilst teleguided operation may be intolerant to network delays. A larger amount of delay- and error-intolerant data leads to the need to increase the transmission capacity, without compromising the reliability and responsiveness of the system. Therefore, mapping the requirements is essential for proper network planning (Boulter & Hall, 2015; Peterson & Dave, 2013).

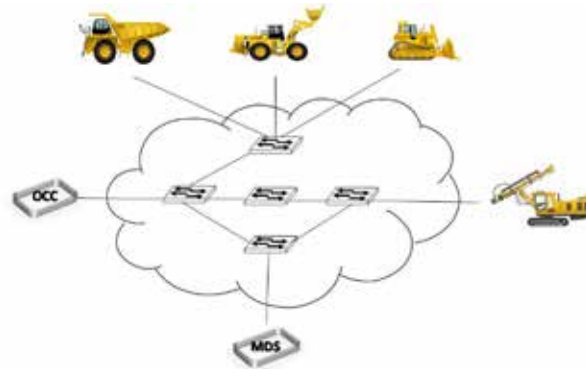

Figure 1 – Assets, OCC, MDS (hosts) are connected through links and nodes of a communication network

In the mining industry, variabilities in topographic and geological domains compound the challenge of making the quality of service provided by the wireless network manageable. Radio waves are sensitive to morphological changes, which can lead to either favorable or unfavorable conditions for telecommunications systems, and the impacts of these changes in the wireless network are still poorly studied in open-pit mine environments. Furthermore, the introduction of foreseen industrial applications requiring connectivity, e.g. the Industrial Internet of Things, will further increase the burden on the mission-critical wireless network. Simply put, the mining environment needs a continuous wireless network planning, monitoring and optimization due to ever changing morphology and automation needs (Garcia et al., 2016).

In this context, we present and discuss the challenges of providing reliable wireless networks to support intelligent mines. First, a brief overview of fundamental communications concepts, necessary to understand the paper discussions, is given. In section “Mining Applications”, the communication requirements of conventional mine applications are presented and compared with the requirements posed by intelligent mine applications. Section “Case Study” presents and discusses network simulations over a real mine deployment considering two different moments in time, 7 years apart, and also the fleet and communications requirements changes. Finally, Section “Conclusions” wraps up this present work.

## WIRELESS COMMUNICATIONS FOR MINING ENGINEERS

In this Section, a brief overview of important communications concepts is presented. Interested readers are referred to Rappaport (2002) for more information.

Wireless communications comprise the task of transmitting information among devices that are not electrically connected. The transmitted signal is, therefore, propagated through the air by different mechanisms such as reflection, diffraction and scattering, which allow the signal to be received even in locations where there is no Line-Of-Sight (LOS) between transmitters and receivers. The dispersion of the transmitted signal over the wireless medium, aligned with the losses associated to these different propagation mechanisms, cause fluctuations in the received power as a function of distance, frequency, receiver's speed and the environment over which the signal is propagated. Another relevant source of random fluctuations over the received signal is the noise inherent of electronic circuits. It is important to mention that noise increases with the bandwidth of the transmitted signal.

Although many types of communication links exist, in this work focus will be given to point-to-multipoint systems, where a central transmitter is responsible for providing connectivity over a given area. The communication range, or coverage probability, is defined as the area within which the received power is above a given power threshold with a certain probability. This threshold also considers the receivers noise and other sources of interferences, indicating whether the original message can be decoded at the receiver side. Usually, this signal threshold is defined in terms of a minimal signal-to-noise ratio (SNR), or a minimal signal-to-noise-plus-interference ratio (SINR), and received signal strength indication (RSSI). Additionally, the definition of the coverage area also considers signal fluctuations caused by the different propagation mechanisms.

Although it is a fundamental concept, coverage itself does not guarantee that a given transmission will be successful. There are different types of data, for example, that are time sensitive. Real-time monitoring, for instance, lose its value if the video frames are not sent with a minimum data rate, for it causes delays in the transmitted data. The Shannon-Hartley theorem (Equation 1) defines the maximum data rate at which information can be sent over a communications channel:

$$C = B \times \log_2(1 + SNR) \quad (1)$$

In Equation (1), C represents the channel capacity, in bits per second, B is the channel bandwidth in hertz (Hz) and the SNR is given in linear power ratio. A direct conclusion from the Shannon-Hartley theorem is that it is possible to increase the capacity of a communication channel by increasing the system bandwidth, or by enhancing the SNR. However, it is important to remember that there are limits for the increase in capacity, since spectrum is a scarce and expensive resource, transmit power levels are strongly controlled by regulatory authorities and that the received power decreases with the distance between transmitter and receiver.

The last two fundamental concepts to be mentioned in this brief overview are the latency and jitter in a communication system. Latency considers not only the delay caused by the channel insufficient capacity but the end-to-end delay in a transmission. Other sources of delay are, for example: collisions in multiple access techniques, insufficient processing power at the nodes or congestion in upper layers. Depending on the application, upper layer protocols, or even the users can deal with latency if it is constant. For example, if the latency of a video transmission is constant but small, in a remote control application, the perception of it by the end user will be minimized, since the flow of information is continuous. Variable latency, or jitter, on the other hand, can damage severely the quality of experience of a user over the network.

It is also worth mentioning that a typical system comprises a base station (a tall tower usually located in a high place to have a better LOS) and a number of nodes and relay stations (for example cell-on-wheels) to extend the radio coverage and/or capacity. Finally, the choice between commercial carrier services and a private infrastructure hinges on service availability, costs, digital security policies, quality of service requirements and the foreseen mining applications.

## MINING APPLICATIONS

Mines are characterized by dynamism and intense topographical changes, as a result of mining excavations. Nonetheless, there are also some communications “hot spots” in a mine, namely, places that will always have equipment around to transmit or receive data. Excluding excavation areas, development areas and haul roads, all being itinerant, ore dump points (crusher area) and waste rock dump (dump area) can be considered fixed. The primary crusher is the interface between the mine and the processing plant: the infrastructure for it, such as conveyor belts and stockpiles areas, is planned to be there for all over life of the mine. Waste rock sites are permanent until they reach their designed capacity with a maximum volume of material. When that happens, a new site needs to be prepared.

Although autonomous systems are still restricted to large enterprises, MDS are common in the mining sector and rely on wireless communications. The average throughput per node for MDS are usually around few tens of kilobits per second (kbps) in the uplink, the link between the host and the network node (the base station, for example), or downlink, defined as the link between the network node and the host. The haulage of Run-Of-Mine (ROM), waste rock and the geographical position of the trucks are monitored from inputs that operators report to the interfaces located in the cabins which, among other options, can inform the MDS if the truck is "full and going to dump" or "empty and waiting to load" or "hauling material" or "maneuvering". Each asset has a roll of typical options to their tasks that are sent periodically to MDS. The system is defined as passive if only monitoring is possible, for example to generate reports containing the Key Performance Indicators at the end of a period. On the other hand, the system is defined as active if it allows for dynamic allocation. In the latter, after dumping the hauled material, a target is given to the trucks by the MDS, to reduce queues sizes at excavations areas, thus increasing individual assets' productivity (Martins, 2013). Optionally, embedded sensors to measure tire pressure, engine temperature, and fuel levels can be installed in the equipment to enable monitoring the machine's performance from the MDS. With these tools, the team of technicians and engineers are able to determine more accurately the best time for preventive maintenance or refueling, reducing the unproductive time and increasing the machine's lifetime – justifying the saying “what gets measured gets managed”.

Horberry and Lynas (2012) describe three levels of automation associated with the mining industry, as shown in Table 1. They differ mainly by the need for remote connection to an OCC that, in the first instance, aims to monitor or teleoperate the equipment. Note that the link that provides the remote connection between the OCC and equipment in the open pit environment cannot be achieved through coaxial cables or optical fibers, due to intense movement and ever changing topography. One alternative solution to establish the remote connection is the use of electromagnetic waves in radio frequency channels that enable the transmission and reception data.

In an intelligent mine, the communication requirements, linked to those applications with a higher autonomy degree levels as listed in Table 1, are not limited to dispatch and telemetry systems: they are integrated to all autonomous tasks to control remotely the whole production. The wireless communications, therefore, will become robust to support all new applications and the merge of OCC and MDS. It is important to note that control applications require higher data rates and are less tolerant to latency and jitter, resulting in strict capacity, reliability and coverage requirements from the network. Video applications, a staple for teleoperated machinery, may consume an average throughput from 2.25 to 7.75 Megabits per second (Mbps) depending on the desired resolution and frame rate. They are very sensitive to the network quality, in terms of bandwidth and latency, *i.e.*, interruptions or delays in real time audio or video are unacceptable. The satisfactory transmission of videos from several machine mounted cameras, the downlink of operational command, and in some cases, the transmission of engine noise enable the operator to run the equipment from a OCC, as if he were running it on the site (Garcia et al., 2016; McHattie, 2013; Peterson & Davie, 2013).

Table 1 – Degrees of automation (Horberry &amp; Lynas, 2012), with current examples

Degree of Autonomy	Description	Example
Low	This category includes perception systems, usually installed in vehicles. The operator has full control of the equipment at all times, handle with alerts and information about system health. The devices are simpler compared to automation systems in large scale. The connection to a OCC is unnecessary.	ToothMetrics™ (“ToothMetrics™ for loaders”, 2013): constant bucket monitoring through videos and automatic identification of missing teeth. The operator received an alert on a screen into the excavator’s cabin.
Mid	Most of the time, the operator has control of the equipment, but some functions are controlled by a system and only supervised. It includes semi-autonomous and remote operations. The connection to the OCC is optional or may be necessary depending on the application.	Leica Geosystems Mining® (Korane, 2013): the unmanned (track or wheel) dozers can clear and prepare a particular area.
Full	Most of the tasks are controlled by software. Human-element issues here might include ongoing supervision of operation. The connection to the OCC is required.	Komatsu’s FrontRunner® (Korane, 2013): the trucks are monitored from the OCC and run on the hauling road under the supervision of remote operators.

## CASE STUDY

### Preliminaries

In order to evaluate the impact of the mine topography variation and the fleet variation over the time on the quality of the service provided by the wireless network infrastructure, we now present this case of study. It considers the mine topography, fleet (bulldozers, haul trucks, drill rigs and loaders) and wireless network infrastructure in two distinct points in time: 2007 and 2014. The following terminology is adopted for the coverage and capacity’s simulations of the wireless communication in an open-pit mine:

- *Conventional mine*: the communication network requirements are limited to telemetry and dispatch (narrowband) applications;
- *Intelligent mine*: the communication network requirements includes (wideband) applications of video, audio, commands and high-precision positioning, in addition to telemetry and dispatch applications, due to the higher automation degree associated with machinery operation.

By means of two digital surface models corresponding to 2007 and 2014’s surfaces, it was possible to simulate the behavior of a given wireless communication network infrastructure using a network planning tool, such as Atoll®, considering a number of assets with their respective geographical positions and average throughputs. Table 2 shows 2007 and 2014’s fleet and their communication requirements for applications of a conventional and intelligent mine.

An increase of 38% in the quantity of assets in 2014 is justified by the increasing average hauling distance, increasing stripping ratio and reduced physical availability of initial fleet. Therefore, for the ROM

production not to decay along time, the fleet needed to become bigger. If the mine continues to operate conventionally in 2014, traffic on the communication network increases proportionally. Also, if a mine plans to employ equipment with medium or high degrees of automation in its operation, it should prepare the wireless network to support new applications. In this study case, the aggregated demand (offered data traffic) for an intelligent mine in 2014 is more than 44 times greater than the total of a conventional mine in 2007. Briefly, more capacity is required for autonomous applications.

Table 2 – Number of hosts, data requirement and total rate (uplink) in an iron ore open-pit mine

Assets	Number in 2007	Number in 2014	Average throughput (kbps)		Data services enabling automation
			Conventional	Intelligent	
Bulldozer	3	5	32	3 500	Video, audio, commands, telemetry, dispatch, precision positioning. Teleoperated asset.
Drill rig	2	4	32	3 600	Video, telemetry, dispatch, precision positioning. Operated asset by software.
Haul Truck	26	32	32	500	Telemetry, dispatch, precision positioning. Operated asset by software.
Loader	6	10	32	500	Video, telemetry, dispatch, precision positioning. Operated traditionally.
Conventional mine aggregated demand in 2007				1.2 Mbps	
Intelligent mine aggregated demand in 2014				52.9 Mbps	

As a rule, the communications network is designed to fulfill the application requirements. Thus, it is necessary to ensure coverage and capacity for applications, but the latter is not necessarily uniform throughout entire the area of the mine, but at least within the area where the equipment is expected to be located. Each asset is located within a specific polygon, according to mine scheduling, as shown in Table 3.

Table 3 – The fleet is allocated into specific polygons (regions)

Geometry's name	Total area (km <sup>2</sup> )		Features of allocation
	2007	2014	
Development	0.2364 11.2%	0.6197 15.4%	These areas are prepared for future exploitation by <b>drills and dozers</b> .
Excavation	0.0713 3.4%	0.1124 2.8%	Extraction areas where the <b>excavator</b> loads the <b>truck</b> . <b>Dozers</b> are also common here.
Hauling road	0.1528 7.2%	0.3446 8.6%	Areas linking the excavation areas to dump points (crusher and waste pile). Roads for <b>trucks</b> and <b>dozers</b> .
Crusher	0.0022 0.1%	0.0056 0.1%	Areas for dumping ROM. It is common <b>trucks</b> and <b>dozers</b> .
Dump	0.0890 4.2%	0.5040 12.6%	Areas for dumping waste rock. It is common <b>trucks</b> and <b>dozers</b> .
Area total of operational mine	2.1180 100%	4.0150 100%	Area of entire mine (including the ones witch there isn't any equipment allocated in).

In this simulation, 5 types of polygons were considered to allocate equipment in. Figure 2 shows a part of the mine where some polygons are enclosed at (a) 2007 and (b) 2014. The development area corresponds to the future area that will be mined, and those places depend upon the orientation (dip and direction) of the geological body, so, drill rigs and bulldozers should be located in these areas. The excavation areas are characterized by loader tasks and these areas are connected to the crusher and waste dump through hauling roads. Bulldozers are found in all the created polygon geometries due to its flexibility and mobility inherent to its work, while trucks can only run in roads previously prepared. Table 3 also highlights in its last column the assets that were allocated into a specific geometry for the simulations.

Figure 2 shows the same enclosed mining area ( $1.163 \text{ m} \times 2.314 \text{ m} = 2.691 \text{ km}^2$ ) from 2007 and 2014 and the position of some polygons, as well as a comparative figure showing the variation in height within the mine area. Figure 2 (c) shows the areas that have become deeper in blue, and the areas that had their heights increased in red.

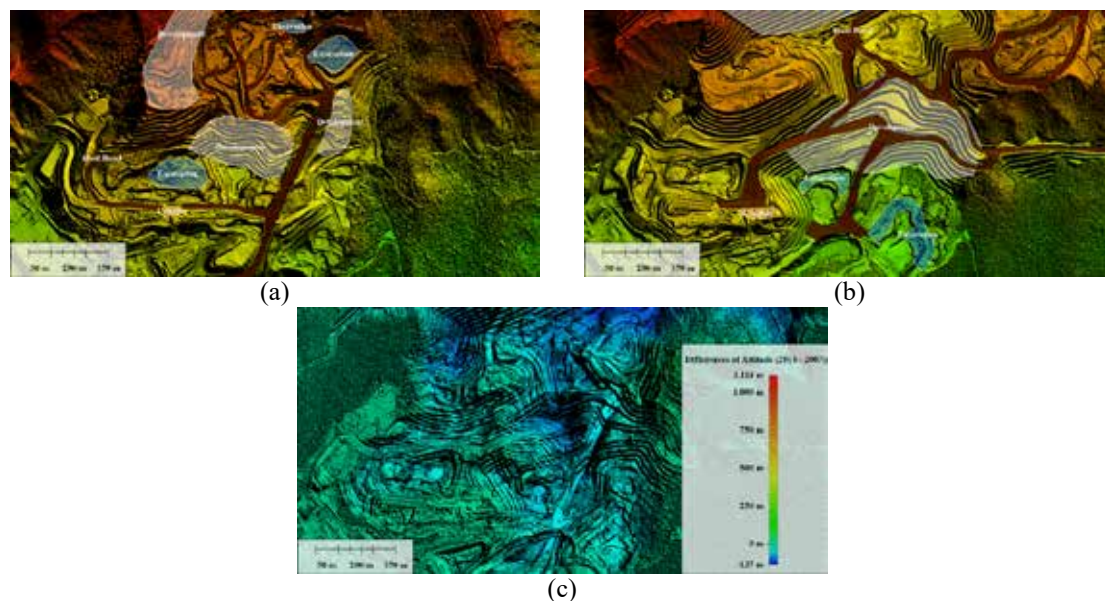

Figure 2 – Mining evolution. Dark brown regions refer to haul roads, white ones to development areas, the blue ones to excavator areas and the pink one to the crusher area: (a) 2007; (b) 2014; (c) Mine topography change between 2007 and 2014

### Network Planning

The next step in evaluating the impact of fleet increase and topographic variation on the quality of service provided by the wireless network is to simulate a given wireless network performance over time using a network planning software. The first simulation considered the deployment of a network infrastructure capable of providing the services shown in Table 2, for the conventional mine scenario. In order to design such a network, it is important to consider the traffic constraints, the local topography as well as practical issues such as the optimal (and feasible) location to place base stations (macro and small cells of communication). The deployment of macro-cell base stations (tall tower) is expensive and, ideally, their location should not change over time. Consequently, it is interesting that network-planning engineers are in contact with mine-planning engineers to evaluate candidate points, desirably on the border of the mine that will not be mined. However, this is not always the case; the macro cell location is chosen considering the topography at the time of the initial deployment.

Considering the contour of the mine, the task of the network-planning engineer is to select locations to place the transmitter such that the coverage, capacity and latency requirements are met as cost-effectively as possible. In order to do that, the engineer should perform a set of simulations selecting the transmitter



parameters, such as location, height, bandwidth, transmission power, antenna types, tilt (inclination of the antenna) and the desired communication system. In these simulations, the authors considered a Long-Term Evolution (LTE) network, with the parameters presented in Table 4.

Table 4 – Transmitter parameters for conventional mine

Transmitter	Parameter
Height [m]	40
Transmit power [dBm]	36
Downtilt [°]	0
Bandwidth [MHz]	5
Frequency [MHz]	1800
Antenna [type]	Omni
Antenna gain [dBi]	11

The network planning software employs propagation models that, in summary, relate the variation of signal level with the distance, frequency and type of scenario to predict the signal level in all points within the desired area (Rappaport, 2002). In the results presented below, the Standard Propagation Model, calibrated with real measurements results, was considered. Figure 3 (a) shows the Reference Signal Received Power (RSRP) levels in this simulation. As explained in Section “Wireless Communications for Mining Engineers”, the received power levels are related to the achievable data rates applications running over the wireless network will experience.

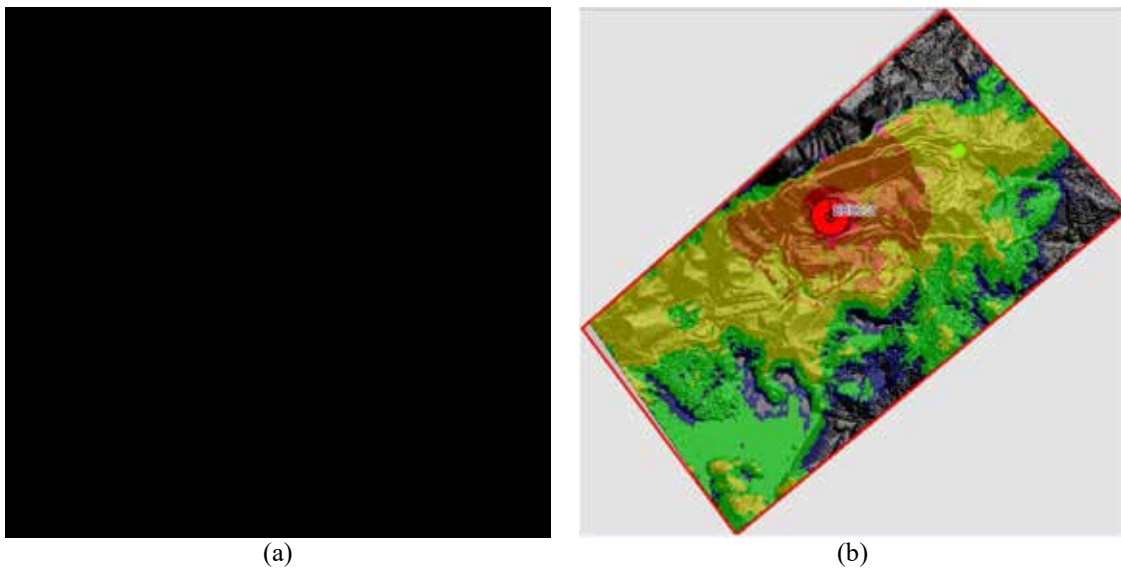

Figure 3 – RSRP levels for: (a) 2007 Macro deployment and (b) 2014 Macro deployment. The red circle represents the cellular tower.

In order to capture the effects of the statistical variation on the channel realizations, and also the impact of the change in position of the network clients over the zones defined in Table 3, a Monte Carlo simulation was performed. In Monte Carlo simulations, the users are randomly positioned within the regions of interest and the results are collected in a “snapshot” of the network performance for a given set of parameters. The results are stored, and then new simulations are repeated, with new users’ positions and channel realizations. After several snapshots, the resulting statistical distributions are analyzed and the mean values and standard deviations of the desired metrics are calculated. In Table 5, we summarize the percentage of satisfied users as a function of the network deployment and user requirements. We present two network deployments: the macro deployment, and the heterogeneous deployment, a combination of macro and small cells. As detailed in Figure 3, although the network deployment is the same in 2007 and 2014, there was a

topographic change between the two years, causing impact on the coverage. Concerning the traffic requirements, we follow the description detailed in Table 2: conventional and intelligent mine traffic.

Table 5 – Percentage of connected users in different moments in time, and distinct traffic conditions.

Network Deployment	2007 Macro deployment	2014 Macro deployment	2014 Heterogeneous deployment
Traffic Requirements	Conventional Mine	Intelligent Mine	Intelligent Mine
Equipment type	Percentage of satisfied users (%)		
Haul Truck	100.0	40.0	99.2
Bulldozer	100.0	26.6	92.8
Drill rig	100.0	28.9	94.3
Excavator	100.0	36.7	100.0
Total of connected users	100.0	37.8	98.3

From the Monte Carlo simulations, considering the first case, we conclude that this deployment is capable of meeting the requirements of all the conventional mine applications and users, within the polygons defined in Table 3 and Figure 2(a), at the mine in the year of 2007, as shown in the second column in Table 5.

Moving now in time, and taking into account the fleet growth observed from 2007 to 2014, and the topographic variation, we repeated the aforementioned network predictions, considering the same network infrastructure as in the first simulation. Since there was a topographic change between 2007 and 2014 the observed RSRP levels also varied, as shown in Figure 3 (b), in comparison to Figure 3 (a). Actually, in terms of coverage, the results of the year of 2014 are better than the results of year 2007. The reason for that comes from the particular features of this mine that extract ore and waste mainly from the hill, improving the LOS. The extraction of the material, between these years, created valleys and removed obstacles for the wireless signal, extending the coverage of the LTE transmitter.

However, when we look at the applications that need to be served by the initial network infrastructure at 2014, we see that there was a drop in the percentage of connected users (third column of Table 5). The main reason for that is that the infrastructure deployed in 2007 does not provide enough capacity to serve the traffic demand of an intelligent mine. The practical consequence of the lack of capacity, and resultant increased delay, is that the autonomous equipment may not receive adequate (and timely) control information, halting its operation to avoid malfunctions. In the long term, frequent operational downtimes may bring substantial production losses.

In order to meet the demand of an intelligent mine, it is necessary to increase the system's capacity. There are many alternatives to achieve that goal. The first one is to increase the bandwidth of the system. For example, if we had considered 20 MHz instead of only 5 MHz, the capacity of the LTE macro cell would increase. However, spectrum is an expensive and tightly regulated resource. For example, Brazilian government got R\$ 5.85 billion in the auction for the use of 4G spectrum among telecom operators. Therefore, one common approach is the use of Industrial, Scientific and Medical (ISM) band for increasing the total available bandwidth. However, the ISM band is unlicensed and prone to high interference levels, which may not be suitable for reliable applications. A successful approach to increase a system's capacity is to increase the number of networks nodes, or base stations, and reuse the available spectrum by sharing the available set of frequencies among the new transmitters. In this approach, it is very important to ensure that the interference between the network nodes is properly managed.

In LTE networks, the capacity can be increased by adding small cells to the network, which are defined as low power network nodes, placed closer to the ground level when compared to the macro-base station. The combination of small cells and macro cells is usually referred to as a heterogeneous deployment. However, if the small cells share the same spectrum with the macro-cell, it is very important to mitigate the interference between macro and small cells. Several techniques are available, such as inter-cell interference

coordination, that coordinates the use of the spectrum in the frequency by different nodes, and the enhanced inter-cell interference coordination, that coordinates the use of the resources in time.

Each small cell, placed at strategic locations – following the mining face equipment – such as the polygons defined in Table 3, is capable of providing a fraction of the system capacity, according to the fraction of the spectrum (or time) it was allocated with. However, for the frequency reuse to be beneficial, it is important to ensure that the increase in SINR compensates the loss of spectrum and time.

In order to fulfill the requirements of intelligent mining, in the 2014 scenario, there is a need to modify the network deployment. The alternative chosen in this work was to include small cells, at the same frequency of the macro base station. This path was chosen because it reduces the costs associated to acquiring new spectrum; furthermore, in terms of network planning, this is one of the most challenging scenarios. Four small cells were included, with the parameters shown in Table 6. Moreover, the original was moved to an optimized and future-proof location, i.e. no further relocations due to mining activities. The macro cell increases the reliability of the network, for its coverage overlaps with the small cells coverages, working as a backup link in case of failure, or as the main link in areas outside the coverage of small cells.

Table 6 – Small cell transmitter parameters for Intelligent mine

Transmitter	Parameter
Height [m]	20
Transmit power [dBm]	36
Bandwidth [MHz]	5
Frequency [MHz]	1800
Antenna [type]	65° horizontal beamwidth
Antenna gain [dBi]	17

This setup is able to cover the entire mine area, and not only the focus polygons, and also provide much better connectivity, as shown in Table 5, where more 98.3% of the total number of users are satisfied. However, even with the significant improvement and the concern of providing a backup link, the percentage of satisfied users is still far from what is required for automated applications, usually 99.999%. Automated systems are expected to operate seamlessly, and network outages lead to efficiency losses, exposing large equipment and operators to risks, and also exposing the mining industry to significant costs. From Table 5, it can be observed that the two equipment with the largest percentage of unsatisfied users are the bulldozers and the drill rigs, 92.8% and 94.3%. Combining this information with Table 3, that describes the area of each polygon, one can see that the service outage occurs specially in the Development Zone, suggesting that the network plan should still enhance the capacity within that area.

## CONCLUSION

The incorporation of new technologies in open-pit mines is a natural consequence of the computing evolution and workforce reorganizations. Communications systems that suit conventional narrowband applications (dispatch and telemetry) become overwhelmed by the inclusion of wideband applications required to support large-scale automation initiatives, e.g. tele-immersive operations.

The case study simulated the behavior of an LTE (4G) wireless communications network deployed in 2007 that successfully supported dispatch and telemetry applications, but fell short when data traffic increased from 1.2 Mbps to 52.9 Mbps in 2014. The initial infrastructure satisfied only an average of 37.8% of users in 2014. Furthermore, the mine became bigger and more areas needed to be connected by wireless communications.

To solve the problem without acquiring more expensive spectrum, four small cells were included in specific areas following the mining face equipment and the macro cell position was replaced, resulting in 98.3% of connected users. Despite the undeniable improvement, the solution is not, however, a permanent one: the topography and fleet changes require continuous wireless network planning to avoid lack of

coverage or capacity for operations. The integration of radiofrequency (RF) and mine planning processes is the subject of ongoing research. Integration will provide the required knowledge to design an adequate infrastructure, which can ensure quality of service appropriate for the customized mining operation. Moreover, such tight collaboration will lead to a predictable and successfully positioning of the communications infrastructure from the early stages of the mining project, enabling greater scalability, besides having the potential to reduce capital and operational expenditure costs.

## REFERENCES

- Bellamy, D., & Pravica, L. (2011). Assessing the impact of driverless haul trucks in Australian surface mining. *Resources Policy*, 36 (2), 149-158.
- Boulter, A., & Hall, R. (2015). Wireless network requirements for the successful implementation of automation and other innovative technologies in open-pit mining. *International Journal of Mining Reclamation and Environment*, 29 (5), 368-379.
- Garcia, L. G. U., Almeida, E. P. L., Barbosa, V. B., Caldwell, G., Rodriguez, I., Lima, H., Sørensen, T. B., & Mogensen, P. (2016). Mission-Critical Mobile Broadband Communications in Open-Pit Mines. *IEEE Communications Magazine*.
- Hargrave, C. O., Ralston, J. C., & Hainsworth, D. W. (2007). Optimizing wireless LAN for longwall coal mine automation. *Industry Applications, IEEE Transactions on*, 43(1), 111-117.
- Horberry, T., & Lynas, D. (2012). Human interaction with automated mining equipment: The development of an emerging technologies database. *Ergon. Aust*, 8, 1-6.
- McHattie, L. (2013, August). *Advances in mining engineering to enable information mobility for 'intelligent mining'*. Paper presented at the World Mining Congress, Montreal, Quebec, Canada.
- Martins, A. G. (2013). *Simulação das operações de lavra da mina de Brucutu utilizando um modelo de programação linear para alocar equipamentos de carga*. (Master's thesis). Ouro Preto School of Mines, Ouro Preto, Brazil. Retrieved from <http://www.repositorio.ufop.br/handle/123456789/3148>.
- Korane, K. J. (2013). Drones come down to Earth [Magazine article]. Retrieved from <http://machinedesign.com/constructionoff-road/drones-come-down-earth-ugvs-and-driverless-vehicles-reality>
- Peterson, L. L., & Davie, B. S. (2013). *Computer networks: a systems approach*. Elsevier.
- Rappaport, T. S. (2002). *Wireless communications: principles and practice*. New Jersey: Prentice Hall PTR.
- ToothMetrics™ for loaders installed on LeTourneau 2350 [Information on a page]. (2013, September 16). Retrieved from <http://www.motionmetrics.com/installations/toothmetrics-for-loaders-installed-on-leturneau/>.

# THROUGH-THE-EARTH COMMUNICATIONS FOR AUTOMATION IN UNDERGROUND MINES

\*André N. Barreto, Leonardo Aguayo, Adoniran Judson B. Braga

*Universidade de Brasília*

*70919-970, Brasília, Brazil*

*(\*Corresponding Author: [andre.barreto@ene.unb.br](mailto:andre.barreto@ene.unb.br))*

Luis G. U. Garcia

*Vale Institute of Technology (ITV)*

*Avenida Juscelino Kubitschek, 31*

*35400-000, Ouro Preto - MG, Brazil*

*([luis.uzeda@itv.org](mailto:luis.uzeda@itv.org))*



**24th World Mining Congress**

MINING IN A WORLD OF INNOVATION

October 18-21, 2016 • Rio de Janeiro /RJ • Brazil

## THROUGH-THE-EARTH COMMUNICATIONS FOR AUTOMATION IN UNDERGROUND MINES

### ABSTRACT

Underground mining is one of the most extreme occupations from several perspectives. In spite of the extreme environmental conditions, efficiency and productivity are two essential concerns, which must always be maintained during mining operations. Communication is the intersection point for all of the aforementioned concerns and considerations, since it is used at every stage of mining operations.

Different communications technologies are regularly employed in underground mines, mostly employing copper cables and fiber optics, in what is called through-the-wire (TTW), or using radio-frequency (RF) technologies, such as WiFi, in what is called through-the-air (TTA) communications. However, these approaches require a relatively high expenditure, and are not flexible enough to cope with the constantly changing mining environment.

In particular, the vital importance of communication for underground mining becomes evident when an accident occurs. Through-the-earth (TTE) communications systems, in which the radio signal passes directly through the mine overburden, offer the potential to be highly survivable in a mine environment, since such systems are more robust to accidents in the interior of mines, when compared with TTW and TTA networks. Although primarily designed for emergency situations, TTE communications are also potentially useful for mining automation and remote surveillance of mining operations.

However, unlike traditional RF techniques, which are heavily attenuated by soil overburden, TTE relies on magnetic induction using very low frequencies, and have as a limitation a low data rate, in the order of a few kbps.

This paper attempts to demystify the technology and provide a basic overview of how TTE radio works, and what its limitations are, in terms of data rate and range. With this in mind, we also discuss possible applications in the mining environment, from rescue operations to remote detonation and automation.

### KEYWORDS

Underground Mining, Communications in Mining Environment, Through-the-earth Communications, Mining Automation, Communications in Rescue Situations

### INTRODUCTION

In the past few years, the mining industry is increasingly relying on communications systems for different tasks. Initially, these systems were employed basically to connect miners with each other and with the mine administration. In underground mines, this is particularly relevant in disaster situations, in which reliable communication links are essential to coordinate rescue operations. In the near future, reliable communication systems will also be essential to enable the automation of many mining tasks, such as remote controlling or sensing of mining equipment. In order to increase the flexibility of these tasks and reduce infrastructure costs, these systems are likely to be wireless.

In open-pit mines, off-the-shelf wireless communications systems, and, even though some particular challenges are observed, the same concepts of commercial wireless communications can be applied. Underground mines, however, pose higher risks, and represent a much more challenging and little investigated communications scenario. Despite the difficulties, several applications for wireless communications can be thought of also in underground mines, such as automation of mining equipment; explosives detonation; voice and data communication between miners; video surveillance;

monitoring of miners' vital signs; dangerous gases detection, and real-time monitoring and supervision of equipment and personnel.

Currently, the most common approach for providing communication links in underground mines is to lay a traditional communication infrastructure, consisting of cables and wireless repeaters. However, the involved costs, both of capital and operational, are relatively high. Besides that, mines are characterized by a very dynamic environment, with new shafts and tunnels being dug constantly, which requires constant network topology changes and improvements. A further drawback of these conventional solutions is that in case of accidents, such as explosions, fire, flooding, and burial (Barkand, 2006), cables may be severed and wireless access points disconnected.

As in most wireless communication systems, the previous solution uses radio frequencies (RF), employing radiating antennas at high frequencies, such that we are in the far field, and transmits through the air, which is a transmission medium with characteristics similar to vacuum.

Alternatively, a transmission technique that propagates through the soil and rocks would be nice to have, as this reduces the need for a fixed infrastructure. This is possible, employing magnetic induction with loop antennas, using low-frequency electromagnetic waves for establishing a link between the surface and the underground mine. Such systems are called through-the-earth (TTE) communication systems, and an example is depicted in Figure 1.

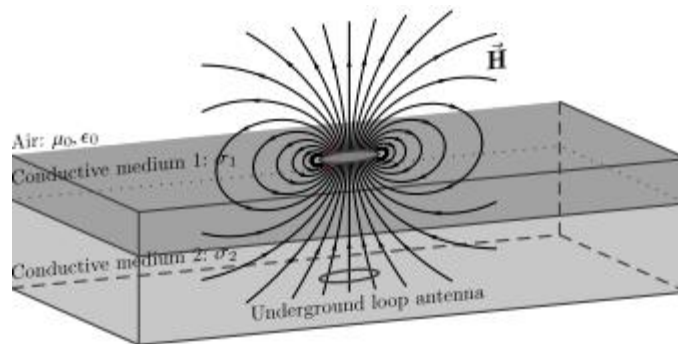

Figure 1. TTE Communications System

Transmitting through the earth is a challenging task, because the presence of soil, rocks, ore, water, and other materials with non-negligible conductivity in underground propagation, imposes a very severe propagation loss, especially in higher frequencies. This restricts the practical communication only to lower frequencies, which naturally also limits the achievable data rate in this scenario (Raab, 1995). The use of low frequencies also leads to power inefficiency in the antennas, due to their small electric size. The radiated power in many cases can be neglected leaving the transmission strength virtually dependent only on the reactive interaction between antennas. Higher frequencies and radiating antennas can be however employed for short-range communications in dry soil.

TTE communication is mainly based on electric or magnetic induction. In a highly conductive medium, the field transmitted through electric field based antennas, such as electrodes, undergoes an extra attenuation of  $20\log_{10}\left(\frac{\sigma}{\epsilon_0\omega}\right)$ , where  $\sigma$ ,  $\epsilon_0$  and  $\omega$  are the electric conductivity, electric permittivity in free space and angular frequency, respectively, when compared with the field transmitted through magnetic-field antennas, such as loop antennas.

Therefore, transmission is usually done by magnetic induction, with frequencies below 30 kHz. Besides the narrow bandwidth and large propagation loss, TTE systems are also susceptible to atmospheric noise and alternate-current harmonics from transmission lines and electrical equipment, which also represent impairments to communication performance, especially in uplink (Raab, 1995).

TTE communication systems have been studied and tested for many decades, but has found until recently very little commercial use. However, recently, US congress issued new regulations, requiring that an emergency communication system for underground coal mines should be made available during accidents. This was named Mine Improvement and New Emergency Response (MINER) Act. According to this, communications systems for emergency situations must be wireless

and bidirectional, provide communication between the surface and underground tunnels, and be capable of locating miners trapped inside mines (Yenchek, 2012). As infrastructure-based communications are likely to break down in an accident, TTE is apparently the only technique employable in these situations, and, therefore, the MINER Act motivated the industry and academia to further develop TTE technology.

Even though the commercial development of TTE transmission was originally motivated by these regulations, and with a specific application in mind, i.e., establishing communications in disasters, it is clearly a technology with many other potential applications, as mentioned above. Nevertheless, before the technology becomes widespread, there are some substantial physical and technical challenges. Among those, one can list: antenna physical size, power levels associated with transmission and small available bandwidth. In this paper we discuss some of these challenges and some transmission techniques that can be employed in TTE systems.

Firstly, we briefly discuss the alternatives for communications in underground mines, including, but not restricted to TTE. Then, we present some magnetic-field and link-level simulation results. We also discuss some aspects related to higher layers in TTE systems, and, finally, we make some concluding remarks and discuss future work on TTE

## COMMUNICATIONS IN UNDERGROUND MINES

In underground mine environments, it is possible to use either wired communication techniques, called through-the-wire (TTW), or wireless techniques. These latter can be either through-the-air (TTA), using radio waves, or through-the-earth (TTE). This paper focuses on TTE, but before a detailed analysis of it, both TTW and TTA are discussed briefly on the following subsections, so that we can understand the advantages and challenges of each alternative.

### Through-The-Wire (TTW) Communications

TTW systems use cables, either electric cables or optical fibres (Yarkan, 2009), both for communication inside the mine and for underground-to-surface communication. Currently, fibres are increasingly being used, as they permit high transmission rates through long distances inside a mine (Bandyopadhyay, 2010). Because of their great capacity, they are used for real-time monitoring of several activities, such as fire protection or automatic systems. However, deployment of fiber optics is costly and inflexible, as fibers must be redeployed every time that the mine topology changes, and are prone to breakages, particularly in a harsh environment with heavy-duty machinery.

Alternatively, leaky feeders can be employed. They use coaxial cables with small openings for transmitting inside a tunnel. These cables use a thin copper layer with small perforations, such that electromagnetic waves leak from the cable, which operates in fact as an antenna array. Leaky feeders support bidirectional communication, commonly for VHF and UHF (NIOSH, 2010), but, due to the power attenuation in cables, it is necessary to use amplifiers located at regular distances, typically from 350 to 500 m. These structures can be seen as a hybrid between TTW and TTA.

### Through-The-Air (TTA) Communications

As a function of sterile mineral extraction, the topology of underground mines change all the time, making deployment of wired techniques challenging. Wireless systems, also named TTA systems, can be easily installed and naturally adapt to the mine expansion. As such, they are more adequate than wired systems. However, even for TTA systems, the adaptation is limited, and coverage expansion normally requires an increase of the telecommunications infrastructure (Yarkan, 2009).

The mining environment is considerably different from the one found in typical wireless terrestrial systems, with some particular mine attributes, such as mine shape and type of access, that have a large influence on the system performance. Factors such as path loss and delay spread are heavily dependent on the mine topology, and may influence the choice of technology and parameters. For example, a surface mine supported by pillars has propagation conditions different from those found in mines constituted by underground tunnels. Besides that, mines differ from each other also by



their compounding mineral, and by the proportion of this material in relation to the others in the overburden separating the surface from the useful mineral. The electric conductivity of the walls influences heavily the channel propagation losses, as well as the channel temporal dispersion. This all means that network planning should be different for each mine.

Many TTA systems are built upon standard wireless communication systems, particularly wireless local area networks (WLAN), that specify lower layers protocol, such as IEEE 802.15.4 or some modification of IEEE 802.11 (Patri, 2013). Considering node distribution and infrastructure limitation in mines, several papers indicate the use of ad hoc networks (Jing, 2010; Chetan, 2011; Lei, 2010; Wu, 2008; Zheng, 2008). In these, a crucial factor is protocol performance, especially those for access and routing control.

### **Through-The-Earth (TTE) Communications**

Following years after MINER Act, NIOSH (National Institute for Occupational Safety) promoted the development of a series of communication and location technologies in underground mines (Yenchek, 2012). Five prototypes were developed by five companies: Alertek, E-Spectrum Technologies, Lockheed Martin, Stolar e Ultra Electronics. Four of them were based on magnetic field detection using loop antennas and the other one was based on electric field detection.

The proposed TTE systems have shown the capability of establishing unidirectional communication and, in some cases, bidirectional communication for voice and text up to 300 m (voice) and 600 m (text) depth. For voice transmission, those prototypes used frequencies from 3150 Hz to 4820 Hz. Some prototypes also possess a location mode based on triangulation, where only a tone is transmitted for uplink. By processing the signals received at the surface it is possible to locate the transmitter.

On some prototypes analogical SSB (Single-side band) modulation was used, and on others digital modulation PSK (Phase shift keying) and/or FSK (Frequency shift keying). Besides that, in some prototypes noise cancelling techniques (Yenchek, 2012) were tested.

Some companies could turn their projects into commercial products (Sullivan, 2010), as listed below:

- Flex Alert, manufactured by the Canadian company Mine-Radio Systems is a unidirectional communication system providing a link from the surface to underground galleries, for personnel evacuation in case of emergency. It uses magnetic field at low frequencies transmitting information to miners' helmets. It consists of a loop antenna with 10 to 120 m length, strategically positioned over the mine. In emergency situations, a signal is emitted from surface to all miners, making their helmet lamps flash (Bandyopadhyay, 2010).
- Personal Emergency Device (PED), from the Australian company MineSite Technology, is a unidirectional communication system providing SMS transmission to personnel inside the mine wirelessly. Even though it allows downlink communication only, it is possible to use a leaky feeder to complete the uplink (Bandyopadhyay, 2010). This system is also used for remote activation of explosives and equipment control.
- After joint tests with NIOSH, Lockheed Martin started commercializing the MagneticLink MCS, which is a self-sufficient bidirectional TTE communication system that supports voice, text and localization, based on low-frequency magnetic waves. Tests at 500 m depth validated voice and text applications, using a 130 m length antenna on the mine surface and a multiple-loop antenna inside the mine.
- The Canadian company Vital Alert (Endeavour, 2014) recently developed a digital TTE system named Canary, providing bidirectional data and voice transmission. Canary's receiver is implemented by means of software-based radio, making it reconfigurable for an operation frequency from 300 Hz to 9 kHz. This device permits adaptive modulation with data rate from 9 bps to 1 kpbs.

Regarding the modulation and signal processing, an overview can be found in (Raab, 1995), which suggests the use of MSK (minimum shift keying) as a modulation technique. This reference also proposes techniques for atmospheric noise cancelling and error correcting codes in order to

provide more robustness to the system. Also, it affirms that it is possible to enhance signal-to-noise ratio (SNR) from 10 to 30 dB using multiple orthogonal antennas and by the application of other techniques, such as adaptive noise cancellation, maximum likelihood detection and decision feedback. Bearing in mind the significant advances in wireless communications in the past couple of decades, the lack of recent studies related to signal processing for TTE communication can indicate potential gains to be obtained in this area.

### TTE PROPAGATION ASPECTS

As mentioned previously, magnetic induction is the most efficient transmission mechanism in TTE communication. However, even magnetic transmissions suffer from higher attenuations, when compared with classical wireless transmissions. For short and moderate depth, the antennas are in near field zone of each other, where the field strength is inversely proportional to the cube of the range. In far field (very large depth), the field strength becomes inversely proportional to the exponential of the range, which is a much higher attenuation than in free-space far field.

Many field attenuation models were proposed considering homogeneous (or almost) soil structure. In practice, the underground is a complex environment composed by many different materials with different conductivities. Even though these models are useful to help us understand the behavior of communication systems, on-site sounding measurements are important to find the optimum operating frequency and necessary transmission power.

There exists an optimum frequency because of the Faraday's law of induction. The induced voltage in the receiving antenna is proportional to the time derivative of magnetic flux incrementing a gain proportional to the frequency. Because of this, the propagation channel transfer function may be modeled as a non-symmetrical bandpass filter with an optimum frequency.

### SIMULATION RESULTS

In order to evaluate the behavior of a TTE transmission link, we show results of two different simulation studies. In the first case, we used a field solver for characterizing the transmission channel and in the second case we used Matlab to simulate the digital communication system in a typical TTE scenario.

#### Magnetic Field Simulation

The use of numerical methods for calculating the fields, densities and impedances from Maxwell's equations has been essential in the modelling of antenna and propagation in more complex propagation media. Commercial software, such as Computer Simulation Technology (CST), used in our simulations, allows the study of electromagnetic fields on several conditions: low and high frequencies, static sources, microwave, RF, among others, using different numerical analysis methods such as FDTD (finite-difference time-domain), FEM (finite element method) or MoM (method of moments).

In the computational environment setup for the TTE transmission simulation, we used numerical FEM in the frequency domain, adjusted to the ULF/VLF bands. In a basic configuration, we performed computer simulations results on a non-stratified medium. Parameters are: loop radius of 1 m, maximum range of 327 m, soil conductivity 0.08792 S/m, and coaxial configuration. Figure 2 illustrates the field intensity attenuation and the channel transfer function, considering suitable theoretical models, the conductive infinite medium (CIM) and the homogeneous semi-space model (HSS) compared with certain normalized frequency value  $T = r\sqrt{\mu\sigma\omega}/2$ , with  $r$  the distance,  $\mu$  the soil permeability,  $\sigma$  the soil electric conductivity and  $\omega$  the angular frequency. The differences observed for higher frequencies is due to difficulties of numerical methods to properly define the bounding conditions in conductive environments. Other simulations show that the accuracy extends to higher frequencies when increasing the width of the environment that represents the soil.

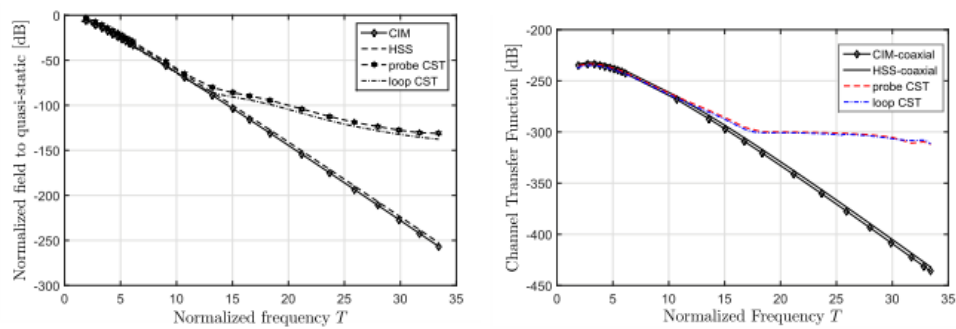

Figure 2. H field intensity and Channel Transfer Function. Comparison of theoretical and simulated models (CST) for CIM and HSS scenarios.

**Link Simulation**

This subsection presents simulation results of a TTE communication link. The purpose of the simulation is to investigate the influence of the TTE channel and atmospheric noise in this system.

To counter the strong attenuation caused by the propagation channel, TTE communications systems should operate at low frequencies, usually in the VLF and LF bands. However, in these frequency bands there are two kinds of noise, generally ignored in the design of conventional communications systems, that impact the performance of TTE communication systems: atmospheric noise and man-made noise.

The atmospheric noise is modelled as the superposition of a Gaussian background noise and impulsive spikes. The impulsive noise component is generated by lightning discharges close to the receiver (up to 1000km), whereas the Gaussian component is due to the aggregate of distant lightning discharges and other noise sources. The noise level varies with location, season and time of the day. The noise spectrum over a typical receiver bandwidth is essentially flat (Raab, 2010).

Several models for the atmospheric noise were developed, but most of them are complicated and difficult to use. The model proposed by Field and Lewinstein (Field, 1978), however, is mathematically simple, easily implemented in simulations and proven to produce accurate results for a variety of noise conditions. This model represents the VLF band noise as a random phasor, whose envelope is the sum of a Rayleigh random variable, that represents the Gaussian component, and a Weibull (power-Rayleigh) random variable, that represents the impulsive component.

Regarding the channel model, we used the conductive infinite medium (CIM) assumption with coaxial aligned loop antennae. We also consider that the centres of the loop antennas are separated by a vertical distance  $r = 200$  m and the soil has conductivity  $\sigma = 10^{-2}$  S/m. Figure 3 shows the magnitude of the channel transfer function for these parameters.

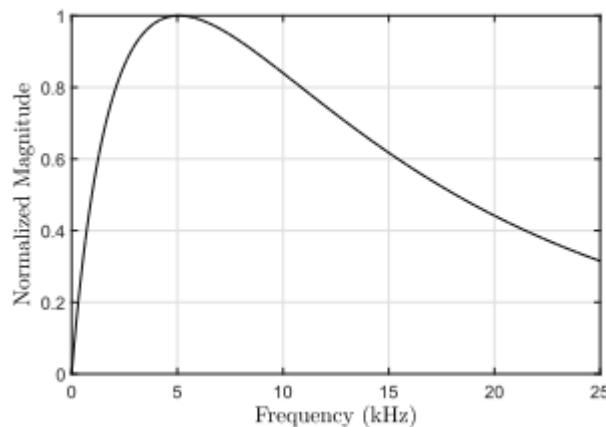

Figure 3. Channel transfer function,  $\sigma = 0.01$ S/m,  $r = 200$ m

The channel is band-pass and frequency-selective, so that intersymbol interference (ISI) occurs. We modulate a carrier in the optimum frequency  $f_{opt} \approx 5\text{kHz}$ , and use binary phase shift keying (BPSK) modulation, with square-root raised cosine (RCOS) pulse with roll-off factor  $\beta = 0.5$ . The transmission rate is  $R = 6\text{ kbit/s}$ , so that the transmitted signal occupies a band of  $B = 9\text{ kHz}$ , centred at  $f_{opt}$ , and it is corrupted by atmospheric VLF non-Gaussian noise.

The detection and demodulation algorithms of a conventional communication system usually assume additive white Gaussian noise (AWGN). As seen in the previous section, the atmospheric noise in the VLF band consists of a Gaussian component and a non-Gaussian component.

Therefore, it is interesting to investigate the performance of conventional AWGN detectors when the noise is non-Gaussian. In addition, as discussed in previous sections, the TTE channel distorts the signal, which degrades the communication system performance, if no equalizer is employed.

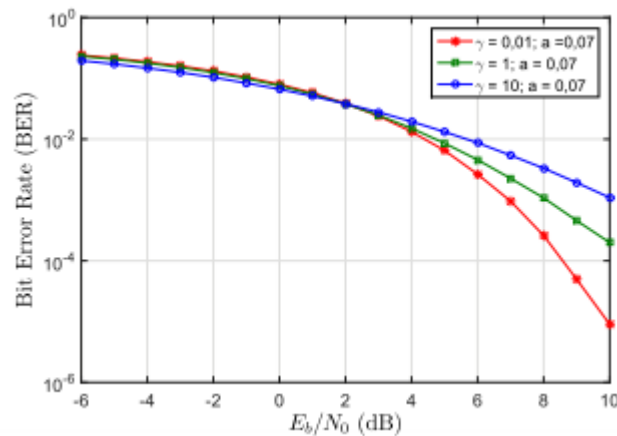

Figure 4. Bit error rate (BER) for TTE communication system, with different levels of impulsive noise.

Figure 4 shows how the TTE channel, described by the transfer function in Figure 3, and the atmospheric noise, described by the Field-Lewinstein model, can affect the performance of a TTE communication system. The curves in show bit error rates for different values of impulsivity,  $\gamma$ , with  $\gamma^2$  the energy ratio between the impulsive noise component and the Gaussian component. When  $\gamma = 0.01$ , the noise is practically Gaussian. When  $\gamma = 1$ , Gaussian and impulsive noise component have the same energy amount. Finally, when  $\gamma = 10$ , the Gaussian component energy is 100 times smaller than the impulsive component energy, which becomes dominant. Note that the performance worsens considerably for larger values of impulsive noise energy. With this simulation, it is clear that we cannot ignore the impulsive noise in the receiver design of a TTE communication system.

## MEDIUM ACCESS PROTOCOLS AND APPLICATIONS

After taking into account the unique aspects of the transmission medium and the point-to-point link, here we considered some aspects for the specification of a suitable datagram and medium access control (MAC) protocol for TTE networks.

Considering TTE communications for applications that are not only related to disaster situations, but also for mining automation applications, the need to implement protocols to allow the communication of different users arises. However, the literature on medium access protocols for TTE communications is practically non-existent, making this one of the major challenges for the research in this area.

Due to low transmission rates, we should think of a robust protocol with a minimal control data amount. Furthermore, as the channel bandwidth, optimal frequency and attenuation depend on the depth and relative angle of the underground terminals, the protocol should consider the possibility of using a variable-length band with different carrier frequencies, and also a variable rate.

We can also cite the need to create an adaptive protocol for each type of application. For example, voice applications require less control data to ensure message integrity than remote detonation.

Another aspect to consider is whether the MAC protocol will be random or scheduled. If access is random, it can take advantage of the variable transmission rate among users to improve the performance of classic protocols such as Aloha, that is premised on the equal transmission rate for all users. If access is scheduled, the use of FDMA and CDMA is hampered by limited bandwidth, and TDMA use tends to be more probable. Therefore, we must study techniques that allow the synchronization among nodes.

Another challenge is that transmission is more difficult in the uplink. This happens because the atmospheric noise is more intense on the mine surface, but also because the transmitting equipment inside the mine is likely to be powered by batteries, and has several power restrictions for safety reasons. One possible solution to this problem is the use of repeater nodes in the mine.

Another aspect, given the low transmission rate, is the need of using compressed messages. However, in this case, any error caused by the transmission channel will result in many errors in the decoding process. In the case of uncompressed messages, the error will be local and can be easily removed with an appropriate signal processing technique for that message type. So, the use of error correcting codes for compressed messages is necessary, and a study must be made to assess which codecs and error correcting codes should be used to optimize the packet size.

Two different scenarios can be considered: first, rescue people buried by landslides. In this scenario, transmission of voice, text and eventually photos and video are of utmost importance for the rescue teams, and source compression techniques for voice and image are essential for communications viability. In a second scenario, regarding detonation and automation of mining equipment, transmission rates may be lower, but the integrity of the communication becomes crucial for successful applications. Here, the use of advanced channel coding techniques and specification of efficient network protocols must be addressed.

## CONCLUSIONS

Through-The-Earth communication imposes severe restrictions on the communication system design. The use of signals at low frequencies is essential to make the attenuation provided by the ground not prohibitive, considering the typical depths for underground mines. The presence of non-Gaussian noise and possible power limited transmissions prevent, in a first analysis, the use of higher-order digital modulations with greater spectral efficiency.

Despite these factors, TTE systems are an alternative to wired solutions or infrastructured wireless networks for communication in mines. In this tutorial we have presented a model of a TTE channel, performed link-level simulations based on this model, and addressed some issues regarding higher-layer protocols.

Mining is a very important industry branch, and reliable communication links are a factor to increase its efficiency. By means of this tutorial we hope to have raised awareness to this promising communications technique, that is likely to gain importance in the near future, and, thus, motivate further studies in this area.

## REFERENCES

- T. D. Barkand, N. W. Damiano, and W. Shumaker (2006), Through-the-earth, two-way, mine emergency, voice communication systems, *IEEE Industry Applications Conference*, 955–958
- F. H. Raab and I. R. Joughin (1995) Signal processing for through-the-earth radio communication, *IEEE Transactions on Communications*, 43(12), 2995–3003
- M. R. Yenchek, G. T. Homce, N. W. Damiano, and J. R. Srednicki (2012), Niosh-sponsored research in through-the-earth communications for mines: a status report, *IEEE Transactions on Industry Applications*, 48(5), pp. 1700–1707, 2012.

- S. Yarkan, S. Guzelgoz, H. Arslan, and R. Murphy (2009), "Underground mine communications: A survey," *IEEE Communications Surveys & Tutorials*, 11(3), 125–142
- L. Bandyopadhyay, S. Chaulya, and P. Mishra (2010), Wireless communication in underground mines, *RFID-Based Sensor Networks*
- National Institute for Occupational Safety and Health (NIOSH) (2010), *Tutorial on wireless communication and electronic tracking; Part 1: Technology overview*
- A. Patri, A. Nayak, and S. Jayanthu (2013), Wireless communication systems for underground mines—a critical appraisal, *International Journal of Engineering Trends and Technology (IJETT)*, 4(7), 3149–3153
- G. Jing and W. Qianping (2010), Application of hybrid routing protocol for mine WSN, *International Conference on Environmental Science and Information Application Technology (ESIAT)*, 3, 353–355.
- B. Chetan, P. Deshpande, B. Gireesh Hegde, S. Srinivas, and G. Narendra Kumar (2011), Analysis of DSDV & AODV for disaster management system in coal mines, *International Conference on Wireless Communications, Networking and Mobile Computing (WiCOM)*, 1–4.
- S. Lei, X. Zhao, Z. Wenyan, and C. Xicheng (2010), Model of ad hoc networks for rescuing in mine, *Second International Conference on Networks Security Wireless Communications and Trusted Computing (NSWCTC)*, 1, pp. 210–213
- D. Wu, R. Li, and L. Bao (2008), A holistic routing protocol design in underground wireless sensor networks, *4th International Conference on Mobile Ad-hoc and Sensor Networks*, 187–194.
- Z. Zheng and S. Hu (2008), Research challenges involving cross-layered communication protocol design for underground WSNs," in *International Conference on Anticounterfeiting, Security and Identification*, 120–123.
- G.A. Sullivan, J.C. Squire, E.W. Baker and G.W. Flathers (2010), To the rescue! *World Coal*, 12.
- Endeavour Magazine* (2014), "New through earth communication system for coal mining, , 11
- F. H. Raab (2010), Noise model for low-frequency through-the-earth communication, *Radio Science*, 45(6)
- E. Field and M. Lewinsein (1978), Amplitude-probability distribution model for vlf/elf atmospheric noise, *IEEE Transactions on Communications*, 26(1), 83–87

Institucional Support:



Editorial Support:



Communication Agency:

Operations Management:

Executive Producer and Marketing:

Commercial Partner – India:

Commercial Partner – Canada/USA:



Promotion:



**IBRAM**  
 INSTITUTO BRASILEIRO DE MINERAÇÃO  
 Brazilian Mining Association  
 Câmara Mineira de Brasil



**24th World Mining Congress**  
MINING IN A WORLD OF INNOVATION

October 18-21, 2016  
Rio de Janeiro /RJ • Brazil